

Locally reinforced timber joints with expanded tube fasteners

A.J.M. Leijten

Delft University of Technology, Fac. of Civil Engineering, P.O.Box 5048, 2600 GA Delft,
The Netherlands

E-mail: A.Leijten@citg.tudelft.nl

The study presented focuses on the development of a novel timber joint.

Traditional timber joints with mechanical fasteners, particular dowel type fasteners, such as bolts exhibit a low strength and an unreliable stiffness and ductility caused by the presence of hole clearance and the unpredictable splitting of timber. The novel joint tackles all of these shortcomings. Local reinforcement glued to the timber members in the jointed area prevents unexpected splitting and results in the enhancement of the strength. By choosing a steel (gas) tube instead of a solid fastener, that fit in an over-sized hole, and by expanding the diameter after assembly of the joint, easy assembly and no hole clearance is insured. Due to the ductile behaviour of the reinforcement and the plastic deformation capacity of the tube the ductility of the joint is guaranteed. To assess the performance of this joints a comprehensive study was performed and reported in this article.

Summarising the experimental results, it can be stated that densified veneer (ply)wood is an excellent material to reinforce the timber joint. It possesses a high embedding strength and stiffness compared to softwood and is able to sustain the high concentrated loads imposed by the tubes. It is demonstrated that the new joint possess a reliable and high strength and stiffness capacity in monotonic loading. When certain requirements are fulfilled the joint shows a superior behaviour in cyclic loading. Design examples show that when used in portal frames a considerable amount of timber can be saved, up to about 40%, compared to joints with traditional dowel type fasteners, without a loss of safety.

Keywords: timber, joints, reinforcement, testing.

1 Introduction

The development of a novel timber joint with exceptional mechanical properties is reported.

The objective of the research presented here is to assess the properties of a completely new type of timber joint. The performance is enhanced by local reinforcement of the jointed area and by a new type of dowel, the steel tube as shown in Figure 1. The novel joint shown has properties which are superior compared to all other existing mechanical timber joints.

The joint was developed in the late-80's – early-90's at Delft University of Technology in The Netherlands, as a reaction to the severe limitation of the traditional connections. As the new fastener is a steel tube, it is occasionally referred to as the tube joint. Another aspect is the use of densified plywood as a means to reinforce the timber in the jointed area. All specific elements of the

joint and its behaviour will be highlighted. A comparison will be made with the application of the traditional dowel type fasteners and the potential benefits will be demonstrated. The reliability of the joint is such that application in statically indeterminate structures is possible and will lead to considerable material savings.

The novel joint under consideration gradually evolved through a number of stages. Paragraphs are devoted to the special features of the joint components, 1) densified veneer plywood (dvw) as a reinforcing material, and 2) the expanded tube fastener which acts as a prestressing element. The experimental test programme of the joints as well as the evaluation of the test results follows. Furthermore, proposals for design rules are given. Timber structures are designed using joints with traditional dowel type fasteners and compared with the application of the new joint. The benefits are summarised in a concluding chapter.

Normally the sequence of scientific research is first development of a model, followed by verification by experiments. In this thesis the emphasis is clearly on the experimental side. The reason for this approach is, 1) due to the unknown behaviour of the reinforcement material and the fastener chosen any failure modes built in to the model could be wrong or irrelevant, 2) to provide structural design information quickly for practical use without having to wait for validation of the models.

2 Dowel Type Fasteners

In Civil Engineering there are three key properties which are of great importance for optimal structural performance. The most important of these are specified as strength, stiffness and ductility. Ideally, connections should be as strong as the timber elements to be connected. How strong, stiff and ductile are our timber joints actually? In the early thirties the first tests on timber joints with steel bolts were carried out in Germany. They focused primarily on the assessment of safe strength values. Johansen [1941] gave a theoretical basis for the strength of joints of this type, assuming elastic plastic behaviour of the timber. In the following decades many studies were carried out to assess the influence of parameters like edge and end distances, wood density, load to grain direction, load duration effects, etc. Tests of joints with dowel type fasteners are well documented, Harding [1983]. The studies indicated the limited strength capacity of this type of joint. Jensen, [1994], notes that expressed as a percentage of the strength of the jointed timber elements, the efficiency of a dowel type joint ranges from 40% to 60%, depending on the type of loading. Premature splitting of the timber often limits the capacity and this explains the trend in recent studies to apply fracture mechanics as shown by Jorissen [1998].

In the past many investigations focussed only on the strength of joints while stiffness was considered a minor importance. The reasons for this are a large scatter of the test results, the large number of parameters involved and the inability to control their behaviour sufficiently. However, a reliable stiffness is important for serviceability calculations, and may even govern the dimensions of the jointed members. Currently, code guidelines for the stiffness of joints are still very crude. As many countries are presently changing from permissible stress to the ultimate limit state design, ductility requires a higher profile. Particularly in statically indeterminate structures, reliable stiffness and

ductility play an essential role in structural performance. It allows to utilise the structural capacity of the timber more efficiently. Therefore, it is essential to continue the search for high capacity timber joints with a better ability to satisfy all requirements of optimal design.

3 The main problems of timber joints with dowel type fasteners

3.1 *Splitting Cracks*

As timber is a highly orthotropic material and dowel-type fasteners impose highly concentrated forces, it is not surprising that splitting cracks occur; thus calling for prevention.

In joints with dowel type fasteners preferably yielding should appear in the steel fasteners (plastic hinges), and the timber should be able to develop its full embedment resistance before cracks appear. Therefore, timber design codes contain spacing requirements which are meant to delay the cracks and guarantee some ductility.

3.2 *Hole Clearance*

The method of manufacturing dowel-type joints is usually associated with low and unreliable stiffness. Although the holes to accommodate fasteners should preferably be tight-fitting to obtain a direct load take up, the tolerances of both fastener and hole diameters makes tight-fitting fasteners virtually impossible. When the bolt or dowel fits too tightly, or the spacing of holes are slightly unequal which causes misalignment of the holes in subsequent members, splitting can be initiated in the assembly stage. To meet these requirements precise drilling equipment a prerequisite. To overcome this problem, there are efforts to drill over-sized holes and use injection resin, as done for steel structures (Rodd et al., 1991). However, for a number of reasons this method is not yet suitable for practice. Therefore, it is inevitable that we get stuck with the current method of joint assembly. Again, easy fit is practical but catastrophic for stiffness, which makes most dowel type fastener joints unreliable, particularly in moment transmitting joints.

4 How to solve the problems

The first problem is to prevent the occurrence of cracks. To facilitate this, the most convenient solution is to protect the timber by gluing some kind of reinforcement onto the surface. At the interface of the jointed section, where the concentrated loads need to be transferred, reinforcement is glued to all timber members separately, Figure 1. In the past, steel plates and glassfibre were examined, however, without much success, (Leijten, 1988). The effect of glassfibre strengthening (50 to 200 gr/m²) was insufficient, although it considerably improved the ductility. Steel plates, though very effective, were regarded as unsuitable for practical application due to many problems such as the necessary gluing precautions that had to be taken. Despite these marginal improvements, glassfibre continued to draw the attention of researchers, Chen et al [1992] and Haller [1996]. Larsen and Enquist [1996] showed that glassfibre reinforcement has advantages in preventing timber splitting and allows end distance reduction. The same applies for reinforcement with punched metal plates which was also investigated by Kevarinäki [1995] and Rogers et al [1994]. Embedment tests of resin injected bolts in timber are reported in plywood reinforced timber joints, Rodd et al [1991, 1994].

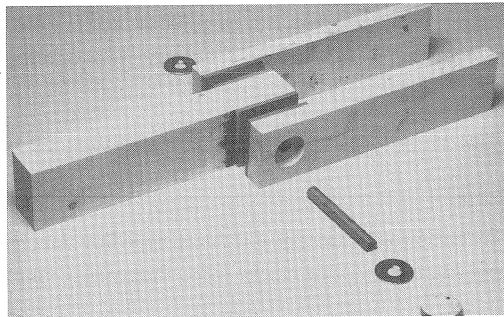

Fig. 1. Tube joint with all elements before assembly. The densified veneer (ply)wood is glued at the interface of the timber members.

Finally, we focussed on an old and forgotten material, densified veneer plywood (dvw). The second problem, that of hole clearance, is easily solved with the use of tubes that fit into oversized holes. This eases the assembly of the joint members after which the diameter of the tube is expanded to obtain a perfect fit. Thus, by slightly extending the expansion, the dvw material becomes even prestressed.

After some tentative tests we were convinced of the potential of this joint and initiated a comprehensive study. More details on the properties of the dvw and the method of prestressing the joint will be presented in the following sections. In Figures 1 to 3 the elements of the tube joint and assembly stages are shown.

The application of this type of connection is not hindered by any patent. The achievement is to make all knowledge available as to provide a new way to enhance the competitiveness of the timber industry.

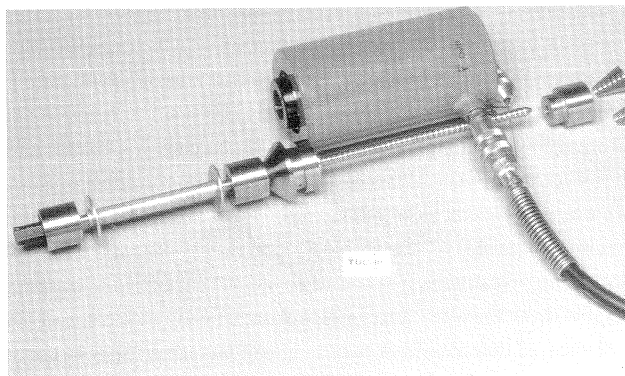

Fig. 2. The equipment to expand the tube diameter.

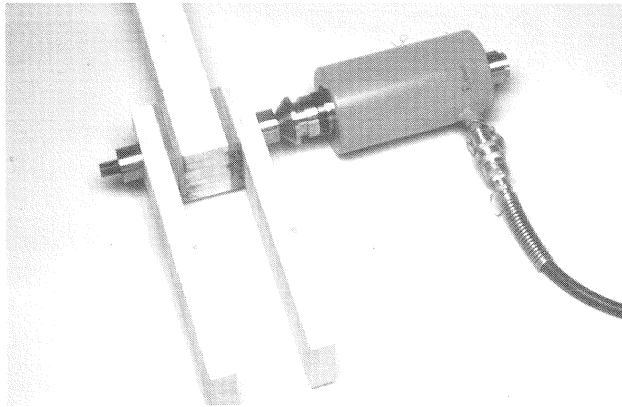

Fig. 3. The assembly stage.

5 Densified Veneer Plywood

This special plywood material has many advantages and is still commercial produced in many countries. Its trade name varies from “Lignostone” in Europe, to “Compreg” in the United States and United Kingdom. As it is wood based, densified veneer plywood is easy to glue using well-known structural adhesives. Only the pointed end of the drill needs to be modified to drill effectively in this highly dense material. No ordinary spiral drill should be used as for steel but a typical wood pointed drill with a center point and precutting edges. Therefore, commercially available spiral drills were cut to suit our purpose. Dvw has a remarkably high embedment strength and stiffness modulus, and in certain circumstances, good ductile properties. We will elaborate on this further more in the following.

Densification of solid wood i.e. compression in the grain direction, was first patented by Robert Stockhart (Leipzig, 1886). In 1922, the Austrian brothers, Pfelemer, found a more effective method of densification, accidentally placing a piece of wood in an autoclave filled with rubber. Due to the high pressure (300 atm) and temperature, the wood was changed to dark dense mass. This densification method gradually improved by trial-and-error, until a more practical commercial method was developed. Rapidly, many densification methods were invented and patented, although few still exist. The method generally used applies compression perpendicular to the grain, combined with high temperatures, Figure 4.

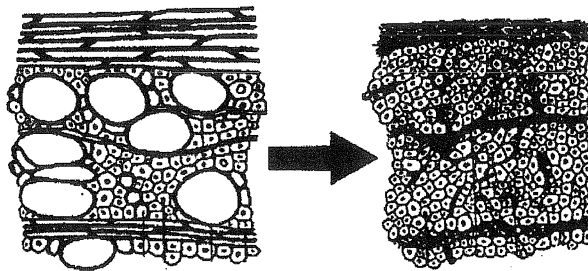

Fig. 4. Microstructure poplar before and after the densification process.

The densification occurs when wood is placed between heated plates and compressed perpendicular to the grain. The combination of heat and compression causes the lignin, an important cell wall constituent, and cellulose and hemicellulose, to begin to soften at temperatures in the range of 165°C to 175°C (330–350°F). Eventually, through various links of building blocks for macromolecules, the molecular viscous flow facilitates the cell to drift and move within the conglomerate of cells, to all open space veins. New molecular bonds are created and a rapid drop of temperature while still maintaining the elevated pressure, will result in solidification of the material. The wood grain as such is hardly damaged, while the material becomes increasingly homogeneous. Wood that is to be compressed consists of either solid wood, solid laminated wood, or stacks of veneers. Dvw is available in thickness of 6 mm to 120 mm {0.24" to 4.7"}. It is possible to impregnate the material prior to compression with the assistance of chemicals. This improves and influences certain properties such as durability and dimension stability. Although many wood species are fit to densify, beech is the species commonly used in Europe for reasons explained later.

The densification is not completely irreversible but recovery strongly depends on the moisture content of the wood before compression, as well as the use conditions. This shape memory effect depends on the density and type of the densified product, as it takes longer for the moisture to penetrate a more dense material. Swelling leads to a severe decrease of the mechanical properties. For standard indoor climates the dvw of our research can be used. In climates where the relative humidity is for months higher than 90%, the performance of the normal dvw will decrease. In that case resin impregnated veneers are densified to produce dvw which is impenetrable for moisture. The dryer the climate condition the better. The most important source of information about the performance of dvw is the German 1951–1954 Edition of "Technologie des Holzes" by Kollmann.

The following advantages of dvw were anticipated:

- Dvw is a commercially available material and no new glue or gluing procedures need to be applied as dvw is wood based.
- No special surface treatment is required, other than sanding.
- The density of dvw is comparable with high density tropical hardwoods and therefore the drilling of holes requires similar equipment.
- Compared to ordinary timber the mechanical properties are less affected by the direction of the applied load when dvw is produced with cross-wise layered veneers.

- Early tests showed embedding strength values up to 160MPa, Fahlbusch [1951], which is about eight times higher than timber and about half that of steel.
- The modulus of elasticity of dvw is about one tenth that of steel. Assuming that stress concentrations near the glueline edge are related to the product of both thickness and modulus of elasticity of the reinforcement, the use of dvw could well create much lower stress concentrations than for instance steel.
- Since splitting is prevented, bigger fasteners can be used than for traditional dowel type fasteners and so the number of fasteners can be reduced.

5.1 *Mechanical properties of dvw*

The type of dvw used for this research, cross-wise layered beech dvw and its application as timber reinforcing is now elaborated.

In Table 1 an overview is given of some mechanical properties of cross-wise layered dvw obtained from research performed in the thirties at standard conditions 20°C and 60 % m.c. For these conditions the dvw will obtain an equilibrium moisture content of 7 %.

Table 1. Mechanical properties of cross-wise layered beech dvw.

mechanical properties for a minimum density of 1300 kg/m ³	mean value [MPa]
in-plane tension strength	90
in-plane compression strength	70
in-plane shear strength	15
modulus of elasticity (young's)	16000

5.1.1 *Veneer grading*

It is envisaged that when applied in timber joints the dvw takes part in transmitting the concentrated forces introduced by the fasteners and therefore the dvw is liable to split or to fail in embedment. As small edge and end distances for fasteners are preferable grading of the veneers might help to reduce the danger of unexpected edge or /and end grain fracture caused by a large scatter of the relevant mechanical properties. The last decades the ability to strength grade veneers has improved considerably. The strength grading is based on non-destructive methods to determine strength correlated parameters. The veneer grading method consists of launching a shock wave in the grain direction into one end of the material. At the other end the leading edge of the wave is detected and the time elapsed is recorded. This method has been employed successfully to improve the reliability of laminated veneer lumber, Bechtel (1986).

One of the important questions was thus whether the scatter and magnitude of some mechanical properties of dvw would be veneer strength grade dependent. In order to answer this question about 1424 veneer sheets of 1x1m² were strength graded manually by a standard ultra-sonic method. A number of dvw properties such as the in-plane tension strength and bearing or embedment strength were determined and the effect of grading analysed.

5.1.2 In-plane tension strength

One of the few examples of the effect of veneer grading is reported by Riechers (1939) for the in-plane tension strength of uni-directional dvw, see Figure 5. Curves fitting the normal distributions are added. Grade B and C represent non-classified material while Grade A veneers are carefully selected on the basis of the visually observed defects. The difference between Grades B and C is not reported. The grading effect of the in-plane tension strength is appreciable. However, no details about the grading method Riechers used could be found.

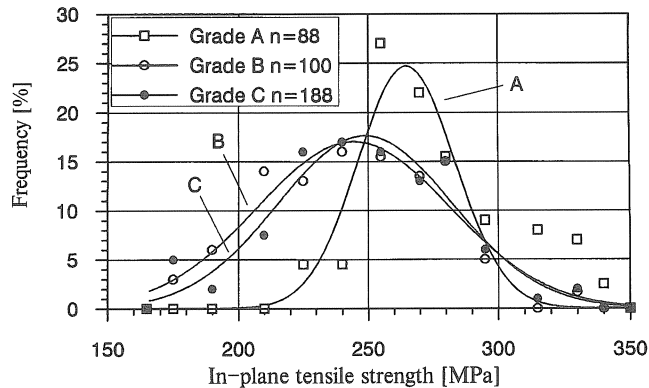

Fig. 5. The effect of veneer grading on the in-plane tensile strength of uni-directional densified veneer plywood (dvw) by Riechers (1939).

Every one of the 1424 veneer sheets consisting of three wood species, was assessed for its grade (quality) before it was made up into a dvw panel. For beech 970 sheets were graded and allocated into three classes, Grade X, A and B, where X stands for excellent and A for good and all others go into Grade B, Figure 6. Stacks of veneer sheets of every grade were densified to obtain dvw panels of 8 to 18 mm thickness. In this way 8, 37 and 31 Beech dvw panels of Grade X, A and B could be produced, respectively. For poplar and maritime pine the number of panels was less because of the more limited number of veneer sheets. From the dvw panels test specimens were cut to be tested in in-plane tension compression and embedment to determine the grade effect. Other specimens were assigned for delamination and embedment creep tests. To make a comparison some of the left over veneer sheets were also cut and tested. Analyses of the dvw test data showed no sign of any grading effect. In Figures 7 and 8 the combined beech veneer and dvw test results are presented. The graphs show the in-plane tensile strength versus density and the dynamic modulus of elasticity, respectively. More details are presented by Leijten, (1998). The densification process increases the mean density of beech by a factor of two. The mean veneer strength is about 50 Mpa and the associated dvw in-plane tensile strength is roughly 100 MPa, which compares well with the density increase ratio. Surprisingly the dynamic modulus of elasticity is not affected by the densification.

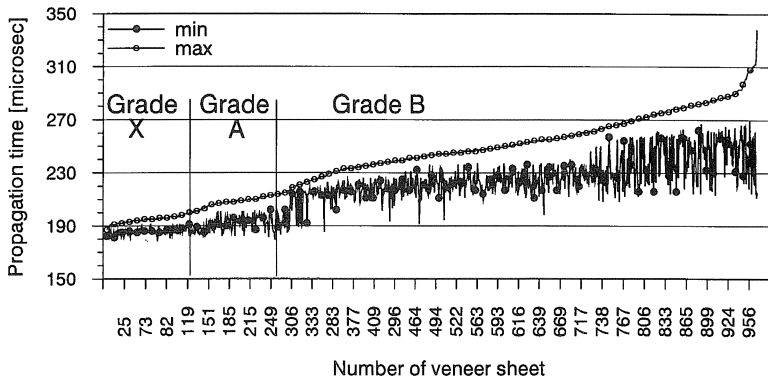

Fig. 6. Grade assignment of beech veneers ranked for maximum propagation time.

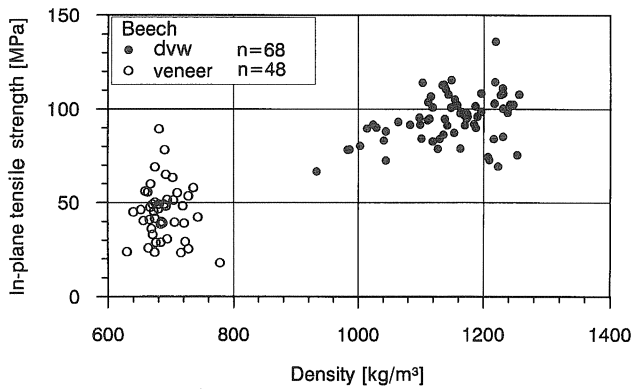

Fig. 7. In-plane tensile strength versus density; combined beech veneer and dwv test results.

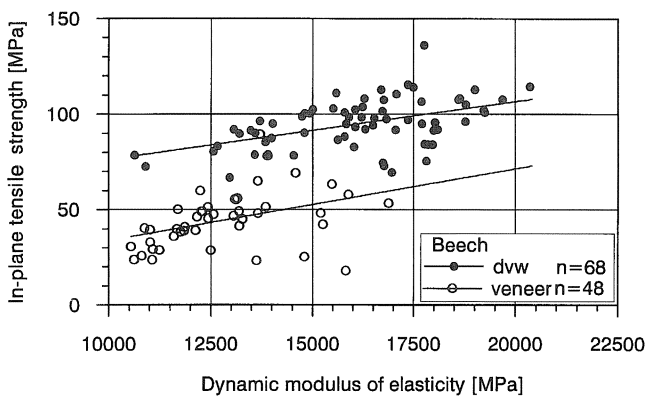

Fig. 8. In-plane tensile strength versus MOE; combined beech veneer and dwv test results.

5.1.3 The embedment tests

An important material parameter for the application in joints is the embedment strength. For structural timber, European Spruce, the embedment strength is about 20 MPa. In the 1920s, Fahlbusch reported some dwv test results which indicated values of about 120 to 160 MPa. A more comprehensive investigation was carried out by Ehlbeck and Werner (1992), and Rodd (1993) which are reported here. Veneers of beech, poplar and maritime pine as well as some eucalyptus veneer sheets were used to produce the dwv specimens. The tests can be performed in tension or compression. As envisaged there was no significant difference between the embedment strength in tension or compression. The reason for performing the tensile tests was to obtain information with respect to the minimum end distance, i.e. that distance for which the embedment strength is reached without premature splitting. The embedment tests were performed using end distances of 2, 3.5 and 5 times the dowel diameter. Premature splitting was prevented for a minimum loaded end distance greater than or equal to 3.5 times the tube diameter combined with a minimum dwv thickness of 12 mm and 18 mm, combined with 17 mm and 35 mm dowels, respectively. The embedment data is presented in Figure 9 and shows that the embedment strength is strongly density and wood species dependent.

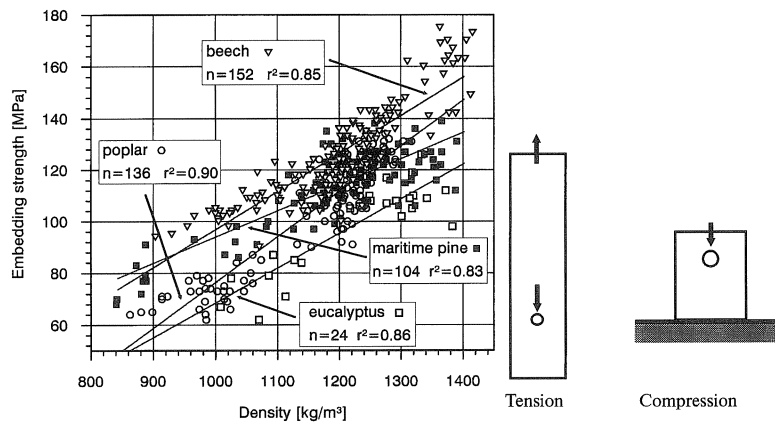

Fig. 9. The embedment strength dependency on density and wood species. The specimens were loaded in tension and compression are shown at the right.

Not only was the embedment strength studied, also the foundation modulus was determined to validate a stiffness model. Figure 10 shows the foundation modulus for the Beech dwv specimens, defined as the embedment stress required for a unite displacement. As this test can be performed in compression and tension mode, the results are slightly different. The dwv specimens were cut in such a way that the veneer face grain was at 45°, 0° and 90° angle with the load direction. In the graph the 0° and 90° angle results are combined. A small but consistent influence of the load to grain angle is shown. The difference between compressive and tensile tests results is mainly caused by the different position of the transducers.

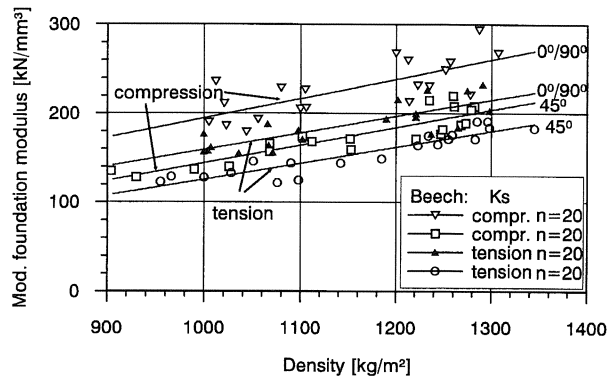

Fig. 10. The foundation modulus of *dw* versus density and load to grain direction.

To summarise the test results:

with respect to the veneer:

- Grading of the veneers with the ultra-sonic method is successful in recognising high quality veneers and allocating it to the grades proposed.
- There is no significant correlation between density and in-plane tensile strength or between density and the modulus of elasticity within a wood species.

*with respect to the *dw*:*

- The veneer grade does not affect the mean in-plane tensile, compressive and embedment strength of *dw* significantly. This hold for *dw* produced with beech, poplar and maritime pine veneer.
- There is hardly any relation between the in-plane tensile strength and modulus of elasticity.
- Comparison of the mean in-plane tensile strength data sets of veneer and *dw* indicates changes proportional to density.
- The load to grain direction is insignificant with respect to the embedment strength and significant but small for the foundation modulus.

6 The Tube Fastener

The next and most crucial step was to develop a new connection method without any hole clearance preferably. As mentioned above, instead of a solid dowel, a tube was chosen to fit into oversized holes before expanding the diameter. The cheapest proved to be the best - low grade, mild steel, galvanized gas pipe Fe360 (ISO 65/DIN 2440), specified minimum yield stress $F_u = 360$ MPa). Most test were performed using 17 mm and 33 mm outer diameter tubes. It should be noted that after expansion they actually become about 18 mm and 35 mm in outer diameter. These figures indicate an allowable misfit of about 2 mm for the big 35 mm diameter tubes. Greater misfits have not been tested. Bigger tubes would require much heavier equipment, particular the hydraulic jack, which no

longer can be carried by one person. Figure 11 schematically shows the expansion procedure. The tube, which is about 10% longer than the thickness of the timber assembly, is pushed into pre-drilled holes. We effectively managed to produce joints with a total thickness up to 500 mm using 35 mm outer diameter tubes. Then, a rod with special end pieces, Figure 12, is inserted in the tube, and using only a lightweight hydraulic jack, the end pieces compress the tube ends, Figures 13 and 14. This results in both forming a flared collar at each end of the tube and forcing the tube to expand in diameter, while the central rod prevents any inward deformation. Evidently, the clearance has vanished completely and immediate load take up is assured. The flared tube ends fit into washers to provide the anchorage for the tube which is required to activate the full embedment capacity of the dvw and the timber at the ultimate limit state, Figure 15. There is only one aspect that needs to be taken care of, that being the overlength of the tube. If it is too long, for instance 20% overlength, the expansion will be too much for the surrounding material, and the whole joint will blow up. Insufficient expansion, such as 5% overlength, will leave some hole clearance and, therefore, result in a reduction in stiffness. 10% proved to be best.

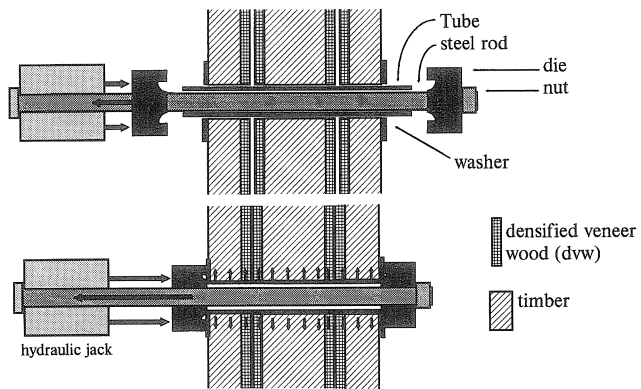

Fig. 11. The principle of the tube expansion.

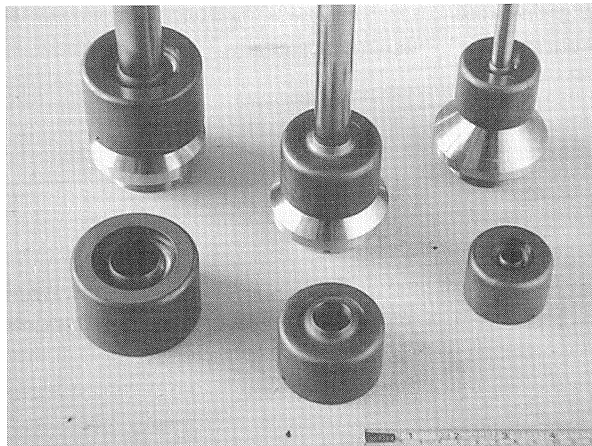

Fig. 12. The special end pieces which assure forming a flared collar at each end of the tube.

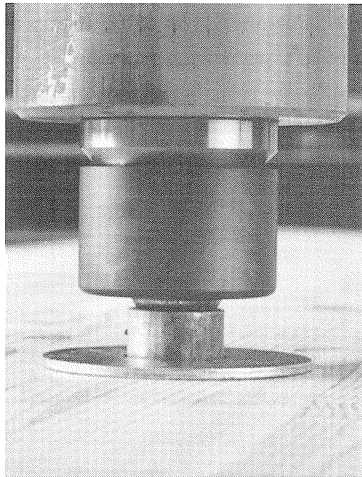

Fig. 13. The start of the expansion procedure with the forming of the collar at the tube ends.

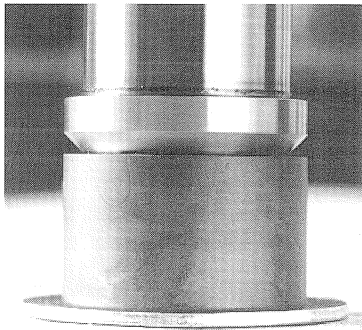

Fig. 14. The end of the expansion procedure.

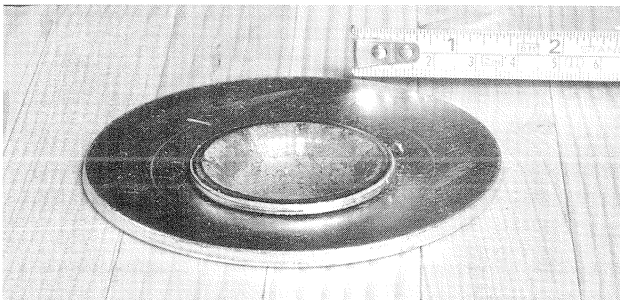

Fig. 15. This is how the expanded tube looks like from the outside.

At the final stage of tube diameter expansion the largest tube expansion appears directly behind the washer, Figure 16. This heavily deformed part of the tube severely crushes the timber. This crushing of fibres generates a sound that triggers the bell to stop the prestress procedure. Another advantage using standard tubes is that the inner and outer dimensions are such that they fit into each other nicely. This allows to increase the wall thickness of the tube fastener by expanding a smaller size tube inside a bigger one, so-called double tubes.

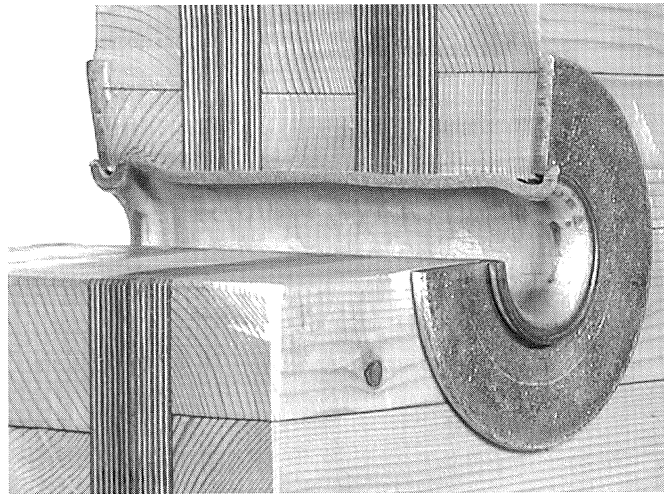

Fig. 16. A cut open view of a test specimen after assembly. Note the perfect fit of the tube at the shear planes and the excessive diameter expansion near the washers.

Summary:

- Inexpensive steel tubes are available with a protective zinc coating
- Over-sized holes, 1 mm or 2 mm mean easy assembly
- Expansion of the diameter of the tube leads to a perfect fit
- Expansion leads to a prestress in the surrounding timber which enhances the stiffness of the joint
- The ductility capacity is assured by the geometry of the tube
- Too much expansion of the tube results in complete destruction of the joint.

7 Experimental Results

Now the essential elements of the joint have been explained, the next step is to highlight the performance of the joint. One aspect is to study the performance in relation with the load to grain angle.

It is well known that the behaviour of joints with dowel type fasteners is dependent on the load to grain direction. This makes it hard to predict accurately the moment rotation behaviour of a

moment transmitting joint where the direction of the forces with respect to the grain direction vary for each fastener. As the dvw is glued to the timber members this effect might be much less. It would at least ease the stiffness calculation in design considerably. Therefore, the main goal of the ramp tests was to determine the load-to-grain dependency of the strength and stiffness of the joint. For all specimens the wood species used was European Spruce with a mean density of about 380 kg/m^3 . Other questions needed an answer as well such as the validity of the minimum edge and end distances obtained with the embedment tests, and the consistency of the load-slip behaviour of the tube joints in the various type of tests. In addition also embedment creep tests were performed.

The joint was tested extensively, and the joint types are shown in Figure 17. Not only were ramp tests performed but also cyclic tests on the parallel joints and full size portal frames with 18 mm and 35 mm tubes. This provided valuable information regarding the energy dissipation capacity and ductility of the joint. More details about the test programme and the results are given by Leijten (1998).

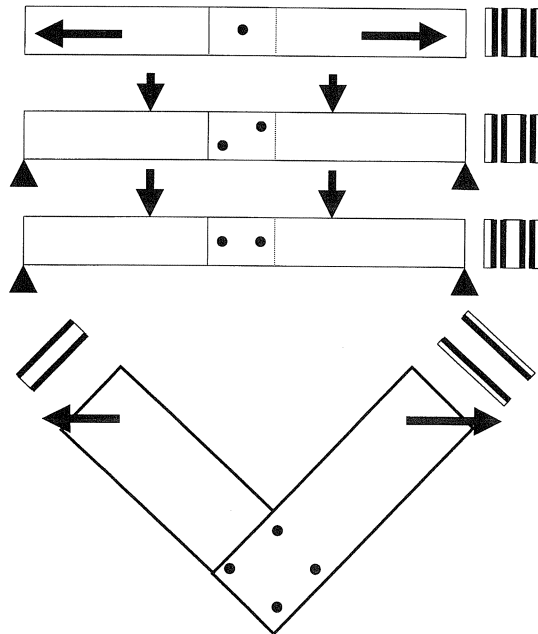

Fig. 17. Types of joints with expanded tube fasteners tested.

7.1 Ramp Tests

Not only was the dvw thickness varied but also the tube diameter as mentioned above. The load, imposed by the tube, to timber grain angle in every type of joint is different. In the parallel tension tests, the load direction coincides with the timber grain. For the pure bending or four-point bending tests, the load was at 45° to the direction of the timber grain for tubes placed in two opposite corners

as shown in Figure 17. The measuring equipment which detects all movement of the middle member with respect to the side members, was located precisely in the centre between the two fasteners. This allowed to check for any differences in load slip behaviour of the two fasteners. In joints made with 35 mm tubes, the dimensions of the outer timber members were 45 mm × 400 mm × 2080 mm and the inner timber were 70 mm × 400 mm × 2080 mm.

In the tests with the knee joints, Figure 17, not only bending moment were transmitted but also a shear force. Located at the centre of the jointed area the measurement equipment enables detection of the movements and to observe the moment rotation and influence of the shear force. The dimensions of the outer glue laminated timber members were 55 mm × 600 mm × 3570 mm and for the middle timber 110 mm × 600 mm × 3570 mm for the biggest specimens. The timber dimensions are given also in Table 2.

Table 2. Dimension of knee joint members.

Tube diameter (mm)	Timber side member thickness (mm)	Timber middle member thickness (mm)	Timber-member width (mm)	End distance (mm)	Side member column length (mm)	Beam member total length (mm)
18	40	80	297	45	1650	1950
35	55	110	600	88	2970	3570

7.2 Regression models

For comparison and evaluation purposes the load-slip behaviour of the joints is characterised by a non linear regression model. Two models were initially compared; the first by Foschi (1974) that is mainly used in timber research, and the second by Jaspart (1991) that is mainly known only in steel research. Foschi's model has three parameters, and Jaspart's model has four parameters. Therefore, it is obviously better equipped to follow the nonlinearity of the load slip behaviour.

Foschi's model:

$$F = [c + b(\delta - \delta_0)] \left(1 - e^{-\frac{a(\delta - \delta_0)}{c}} \right)$$

Jaspart's model:

$$F = \frac{(a-b)\delta}{\left\{ 1 + \left[\frac{(a-b)\delta}{c} \right]^d \right\}^{1/d}} + b\delta$$

in which:

F is the load per shear plane per fastener, N

a is the initial stiffness, N/mm

- b is the post-yield stiffness, N/mm
- c is the load at which the deformation behaviour changes from elastic to semi-plastic, N
- δ is a curve parameter
- δ is the slip or displacement, mm
- δ_0 is the initial slip, mm

The physical meaning of the parameters of Jaspart's model is presented in Figure 18. Foschi's model was unable to represent the load-slip curve with sufficient accuracy, especially since the transition of the linear and hardening branch could not be followed. For this reason Jaspart's model was adopted and applied throughout.

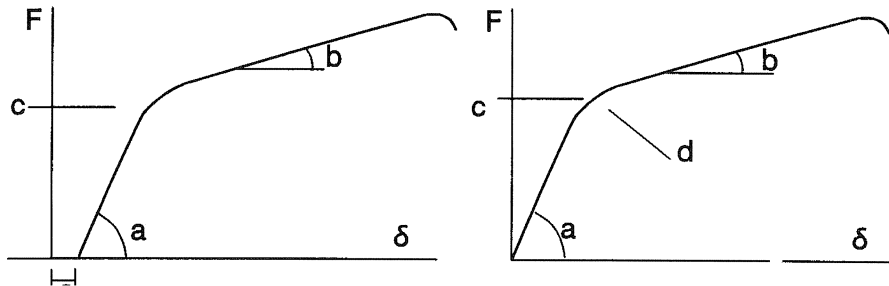

Fig. 18. The physical meaning of the load-slip model parameters. a) Foschi's model, left side, b) Jaspart's model, right side.

7.3 Parallel tensile joints

In the parallel tensile tests two main sets of joints were tested, one with 18 mm tubes and the other with 35 mm diameter tube fasteners. In both the dvw thickness varied as well as the end distance, from $2d$, $3.5d$ to $5d$. Table 3 gives an overview of the test results of the series with the 35 mm diameter tubes. The last column shows the failure mode. Splitting of the dvw means the occurrence of a single crack in the load direction. Plug shear appear when two of those cracks occur. Embedment failure means a very ductile behaviour as indicated by the column with the maximum displacement.

The influence of the short end distance of the joints of Series 10 compared to 11 and 12 is clear. The tests were terminated when the slip exceeds 15 mm. From the analyses of the test results the following conclusions were drawn.

The range of dvw thickness and end distances significantly affects strength, stiffness and other slip parameters.

- The strength does not increase for end distances in excess of 3.5 times the tube diameter for a minimum dvw thickness of 12 mm.
- There is no significant difference in the load slip curve for a minimum end distance of $3.5d$ and a dvw thickness of 12 to 18 mm.

In Figure 19 all load-slip results of all 16 ramp loaded parallel tension joints, Series 8, 9, 11 and 12 with tube fastener of 35 mm diameter are given. The parameters of Jaspart's model are given in Figure 19 as well.

Table 3. Overview of the test results of parallel tension joints with 35 mm tube fasteners 6 series with 4 specimens each.

Joints test series	dvw thickn.	end distance	max.force per shear plane	max. displ.	Stiffness Ks	failure mode
No.	[mm]	[d]	[kN]	[mm]	[kN/mm]	
7	12	2	58.2	3.3	68.3	SP/SB
8	12	3.5	76.8	11.5	68.4	T/SB
9	12	5	81.9	14.5	70.4	T/E
10	18	2	69.7	7.9	85.4	SP/SB
11	18	3.5	77.8	11.1	63.7	T/SB
12	18	5	80.7	12.4	66.9	T

SP = dvw splitting; T = edge distance crack

SB = plug shear failure; E = embedment failure

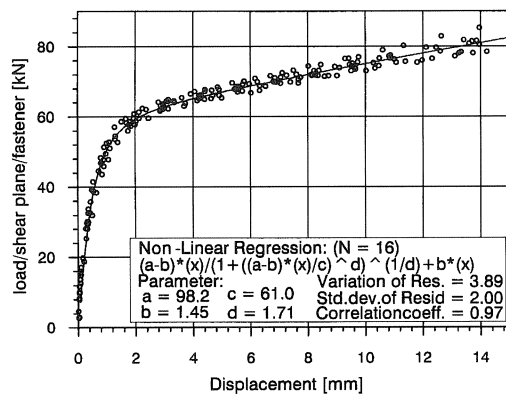

Fig. 19. The load-slip results of 16 ramp loaded parallel tension joints with 35 mm diameter tubes.

7.4 Four point bending joints

In fact two fastener patterns were investigated. One as shown in Figure 17 with fasteners at opposite corners but also one with fasteners on the longitudinal (axial) centre line the specimens.

This was to check for any load to grain dependency in the joint behaviour. The measuring device for the detection of the relative rotation and translation of the joint members was located in the centre between the fasteners. The cross-section of the middle member of the specimens was 35×200 for joints with 18 mm diameter tubes and 70×400 for the joints with 35 mm diameter tubes. An overview of the test results is given in Table 4.

Table 4. Overview of the four point bending test results of joints with 35 mm tube fasteners.

Joints test series	tube diam.	dvw thickn.	end/edge distance	max.force per shear plane	max. displ.	Stiffness Ks	mean bending stress	failure mode
n = 5	[mm]	[mm]	[d/d]	[kN]	[mm]	[kN/mm]	[MPa]	
13*	18	12	2.5/2.5	31.3	6.1	19.8		C/B
14**	18	12	2.5/2.5	28.6	3.6	26.3		C
15*	18	12	3.5/3.5	34.8	8.7	25.3	45.3	C
16**	18	12	3.5/3.5	36.9	11.4	25.5		C
17*	35	18	2.5/2.5	88.7	17.5	38.7	30.9	B/A
18**	35	14	2.5/2.5	72.2	11.5	50.0	30.6	B
19*	35	18	3.5/3.5	91.8	19.1	44.4	25.2	A
20**	35	14	3.5/3.5	83.7	19.3	68.7	26.5	B/A

Test series * and ** denotes tubes placed axially and diagonally respectively

Joints Series 13, 14 and 16 were strengthened

Last Column: A = excessive rotation: B = dvw failure: C = timber failure outside joint

In Figure 20 the load-slip curves of the joints that were loaded in pure (four-point) bending are presented. In order to compare the behaviour of the tube fastener in the various type of tests it was decided to compare the load-slip curves. For this reason we had to transform the moment rotation data to load-slip of the individual fastener. Therefore, it was assumed that the rotation centre stayed in the middle between the two tubes. This was allowed since the measuring equipment detected only small translations; less than 0.2 mm and not until the end of the tests. Again as Figure 20 shows, the scatter is very small and the load take up immediate. This time the tests were not terminated at a joint slip of 15 mm, but continued until the test rig became unstable. Some of the load-slip curves (Series 20) clearly shows the existence of a third branch which indicates ideal yielding. Again Jaspart's regression equation was fitted and the curve parameters determined.

The results lead to the following conclusions:

- A minimum edge and end distance of $3.5d$ prevents premature failure of the dwv and assures a joint with good ductility.
- The load to grain angle did not cause any significant difference in the load-slip behaviour. This indicates an isotropic behaviour of the whole joint.

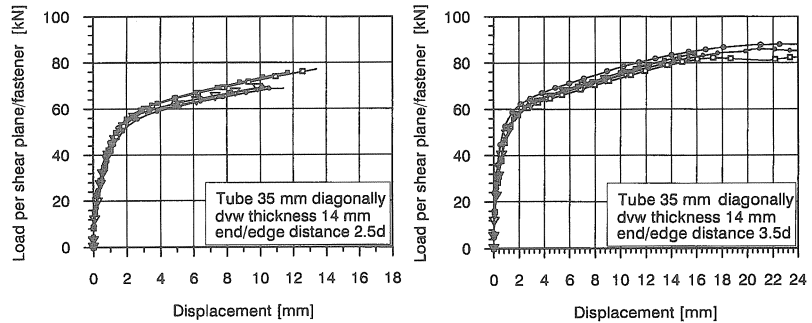

Fig. 20. Four point bending test, Series 18, left and Series 20, right.

7.5 Knee joints

To check the consistency of previous test results knee joints were tested, Figure 17. At the joint not only bending moment need to be transmitted but also shear forces. A earlier developed measuring tool was placed accurately in the centre of the jointed area. as shown by Figure 21. The readings were taken by special transducers. The equipment enabled processing of the readings such that the translations and the rotation of the centre member with respect to the outer members could be recorded and determined independently, Figure 22. The test set-up for the large knee joints with four 35 mm diameter tubes is presented in Figure 23. The ends of the specimen were pulled outwards. The cross-section of the middle member was 105×600 mm for these big specimens. In Table 5 an overview of the test results of the big knee joints with 35 mm diameter tubes are presented.

Table 5. Overview of the test results of the knee joints with 35 mm tube fasteners.

Joints test series	tube diam.	dwv thickn.	end/edge distance	max.force per shear plane	max. displ.	Stiffness Ks	mean bending stress	failure mode
n = 4	[mm]	[mm]	[d/d]	[kN]	[mm]	[kN/mm]	[MPa]	
24	35	18	2.5/2.5	95.5	19	41.3	34.7	A
n = 3								
25	35	18	3.5/3.5	94.0	16	47.9	28.6	A

Last Column: A = no failure, stroke end of hydraulic actuator = end of test

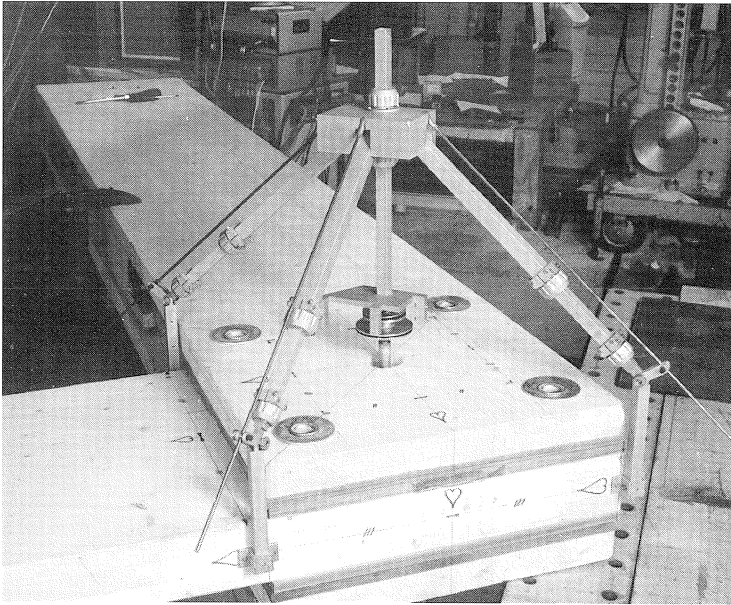

Fig. 21. Measurement equipment placed at the centre of the portal corner joint.

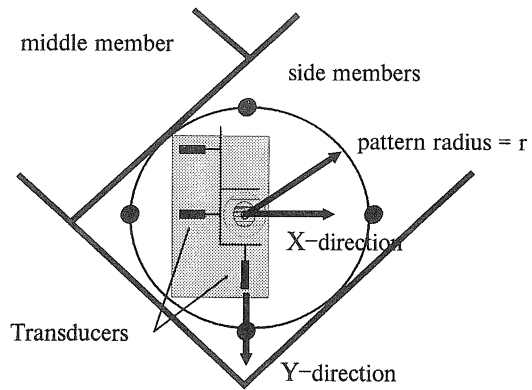

Fig. 22. The principal of the measuring equipment for translation and rotation. Transducers are fixed on plate which in turn is fixed to the side members near the centre hole. Through this hole a square fixed to a threaded rod brings the movement of the middle member in range of the transducers.

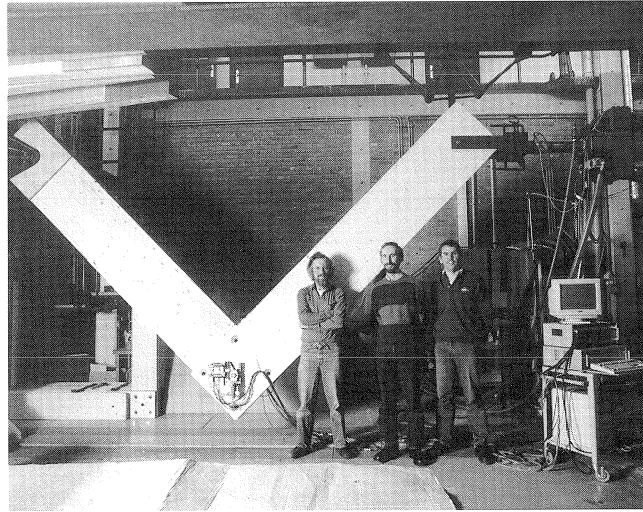

Fig. 23. Test set up of the big moment transmitting joints. At the foreground, from left to right, Mr. Katsma, the author and Mr. Stolle, the test team.

In Figure 24 the moment-rotation curves are shown. Obviously, for a maximum rotation of 0.06 radiant the joints with the smallest edge/end distance showed the largest slip and the highest mean bending stress in the timber members. These mean bending stresses are close to and higher than the assumed characteristic bending stress of the timber (30 MPa), respectively. The top two results originate from two test sets, Series 24 and 25, while the bottom series represent the behaviour of the same joint but without dvw reinforcement and with 12 conventional steel dowels of 24 mm diameter, arranged in a circle pattern. The scatter of Series 24 and 25 is again very small. The difference in strength and stiffness with non reinforced joints is noted. The tests with the dvw reinforced tube joints terminated when the stroke length of the hydraulic equipment was reached, so actually no failure occurred. The joints with dowels finally failure by splitting. The deformations in the tube and the dvw are clearly demonstrated by the cut open view of the joint in Figure 25. Without the anchorage of the tube ends in the washers they would have been pulled inwards and the post yielding stiffness would have been less.

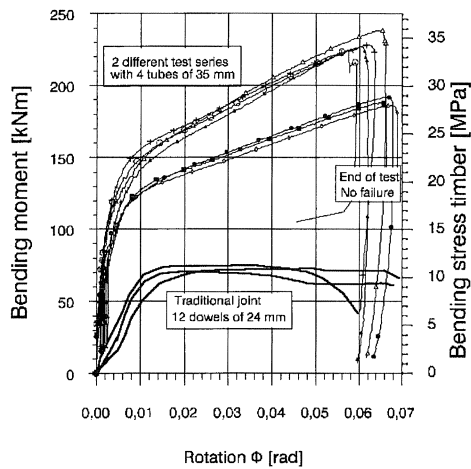

Fig. 24. *Moment-rotation results of knee joints*
 bottom test series: Non reinforced joints with traditional 24 mm diameter dowels
 top two test series: Ddw reinforced joints with expanded 35 mm diameter tube fasteners, top: test Series 24 and below test Series 25.

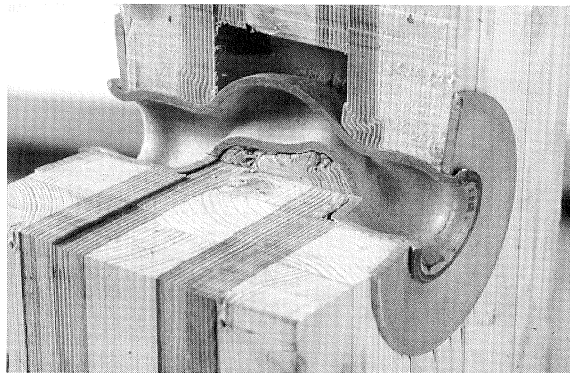

Fig. 25. *A heavily deformed tube after the test. The plastic deformation of the dow and the function of the washers is clear.*

To enable comparison of Series 24 and 25 the moment-rotation curves were transformed to load-slip curves assuming a fixed centre of rotation located in the centre of the fasteners group. It is surprising to note how well the global load-slip curves of Series 24 correspond with Series 25, Figure 26. Jaspert's model was again fitted to the test results. To check the isotropic behaviour of the tube joint the load-slip behaviour of all three type of tests, parallel tension, four-point bending and knee joints, were compared as shown in Figure 27. All regression curves are very similar in initial stiffness, post yielding and transition as well, the regression coefficients are given in Table 6.

It supports the statement that the load to grain angle does not influence any of the regression coefficients and that the behaviour of the joint is very consistent.

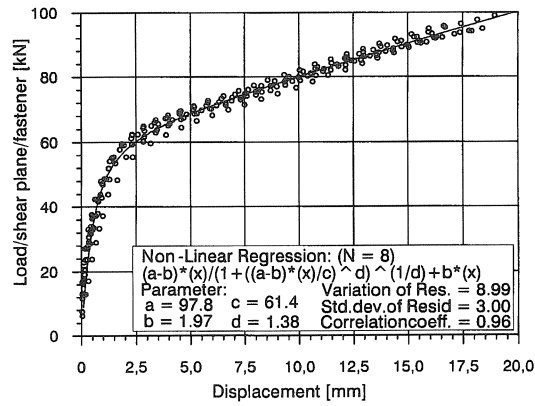

Fig. 26. Jaspert's model fitted to the test results: Knee joints with 35 mm tubes, Series 24 and 25.

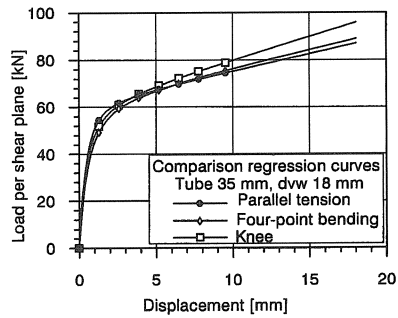

Fig. 27. Comparison and overview of the regression load-slip curves for joints with 35 mm diameter tubes.

Table 6. Overview of the regression coefficients of Jaspert's model.

Joint type	parallel tension	four-point bending	knee joints	parallel tension *	mean
Tube diameter [mm]	35 mm	35 mm	35 mm	35 mm	
Initial stiffness [kN/mm]	a 98.2	90.3	97.8	93.5	95.0
post yield stiffn. [kN/mm]	b 1.45	1.53	1.97	1.76	1.68
transition [kN]	c 61.0	63.2	61.4	60.0	61.4
curve parameter	d 1.71	1.21	1.38	1.78	1.52

* Former test results of Weersink at al. not shown in the Figure 27

The results leads to the following conclusions:

- The load-slip behaviour of a dwv reinforced joint with tube fasteners is to a large degree consistent and independent of the type of test.
- For joints with similar geometry to those used in the tests described, the complete moment rotation and translation behaviour of moment transmitting joints can be predicted using the load-slip relation derived from a simple parallel tension test.

7.6 Cyclic Tests and Seismic Behaviour

In seismic design it is generally accepted that, under a severe earthquake, a structure may suffer a certain level of damage providing that no collapse occurs. This implies that a structure is able to undergo plastic deformations without significant loss of strength, that is, that a suitable level of ductility is available. This ability of a structure to behave in an inelastic mode and to dissipate energy under alternating load cycles is a fundamental aspect to consider. As structural timber behaves brittle in bending and tension, energy dissipative mechanisms should generally be developed in the connections. Mechanical joints represent the only source of ductility that may be mobilised during an earthquake. To find out the suitability of the tube joint for seismic design cyclic tests were performed.

There are a number of basic parameters which reveal the suitability of a joint to resist cyclic loads. One is the ductility, others are the impairment of strength and the energy dissipation. The ductility is the ability of the joint to undergo large amplitude slip in the plastic range without a substantial reduction of strength. It is measured by the ratio between the ultimate slip and the first yield slip. The impairment of strength is measured as the reduction in the resistance for a given slip from the first to the third cycle of the same amplitude, in percentage of the resistance developed in the first cycle. The dissipation of energy is a non-dimensional parameter expressing the hysteresis damping properties of the joint. The joint shall be verified to have appropriate low-cycle fatigue properties under large amplitudes of loads to ensure the intended ductility. An European requirement is that the joint shall be able to deform plastically for at least three fully reversed load cycles at a ductility ratio of 4 (i.e. four times their yield slip) without an impairment of the resistance larger than 20%. In the following the cyclic tests results are given. Full details are given by Cruz and Ceccotti (1996).

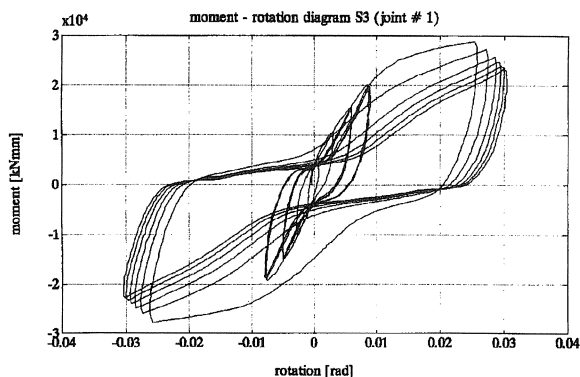

Fig. 28. A typical moment rotation diagram of the cyclic loaded portal frame with four 18 mm tubes at each corner.

The ability to withstand seismic loads was simulated by Cruz and Ceccotti (1996) using a non-linear dynamic analysis. Assuming small portal frames with four 18 mm tube fasteners in each corner, Figure 28, which were designed for snow and wind load as well as seismic loads. Eurocode 8 prescribes for timber structures an action reduction factor $q = 2$ for a design peak-ground acceleration, $A_u = 0.35$ g. The result of the dynamic analysis in term of ground peak acceleration, A_w , which leads to a storey drift of 1/20 height (governing limit) or timber failure are reported in Figure 29 for ground accelerations from different earthquakes. The values of A_y , i.e., the peak ground acceleration that causes yielding of the joints, are also shown. The load reduction factor $q = A_u / A_y$ derived from the average A_y and A_u values given in Figure 29, indicates a q -factor of $1.2 / 0.26 = 4.6$. Therefore, it can be concluded that the portal frames analysed behave satisfactory and higher q -value can be argued for structures with tube joints than for timber structures with traditional non-reinforced joints.

Concluding:

The portal frames tested showed high stiffness, high ductility and high capacity of dissipating energy, and low impairment of strength per cycle.

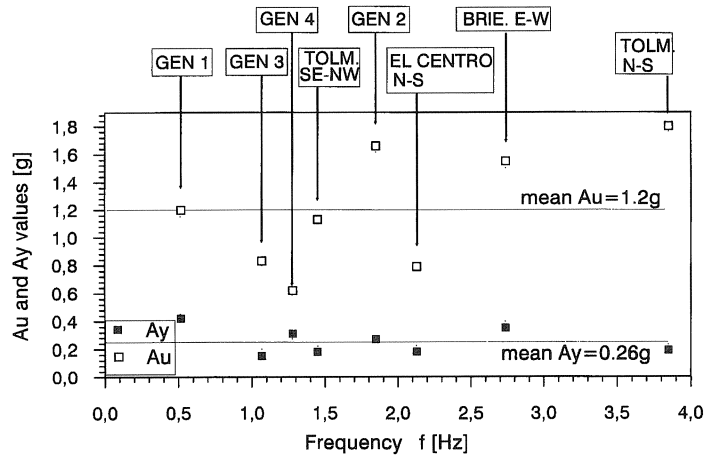

Fig. 29. The results of the dynamic analysis of portal frames with four 18 mm tubes at each joint exposed to various types of seismic loads.

8 Strength and stiffness model

The observations made during the experiments demonstrate that the basic material properties that governing strength are the same as for traditional dowel type fastener joints, namely the embedment strength on condition certain spacing requirements are fulfilled. The plastic moment capacity of the tube fastener hardly contributes to the load-carrying capacity of a joint. Equations of the Johansen (1949) type are therefore less relevant because chord action is dominant. At the shear plane the steel tube finally yields and fails mainly in tension provided a) the embedment capacity of

the dvw and timber is sufficient, b) the tube ends are firmly anchored in the washers to prevent pull-in, and c) the perpendicular to grain strength under the washers is sufficient. Also friction forces which develop along the tube shaft contribute to the strength. It is assumed that other premature failure mechanisms are suppressed by a proper choice of geometrical parameters, like edge and end distances and the spacing between the fasteners. Also the glued area of the dvw should be adequate to transfer the shear forces.

The strength model developed accounts for limitations by the tensile strength of the steel or by the embedment strength of the dvw. The formulae have been verified for a minimum dvw density of 1300 kg/m³ glued to structural timbers like Spruce and Maritime Pine, having densities of up to 650 kg/m³. The first formula represents the limitation of the steel tube when deforming to such an extent that it fails in tension (shear plays a minor role). The second expression represents the limitation due to embedment failure.

$$F_{\max} = \min \left[\begin{array}{l} A_{st} f_{st} \\ (t_1 f_{emb,timber} + t_2 f_{emb,dvw} d_{nom}) \end{array} \right]$$

where:

- F_{\max} is the strength per fastener per shear plane
- A_{st} is the cross-section of the tube
- f_t is the tension strength of the steel tube material
- t_1 and t_2 are the timber and dvw thickness respectively
- $f_{emb,timber}$ is the embedment strength of the timber
- $f_{emb,dvw}$ is the embedment strength of the dvw
- d_{nom} is the tube diameter

In cases where the timber member thickness $t_1 > 2 t_2$ the value of t_1 substituted should not exceed $2 t_2$.

The embedment strength of Spruce and dvw are given below.

$$f_{emb,timber} = 0.09 (1 - 0.01 d) \rho_{timber}$$

$$f_{emb,dvw} = 0.14 \rho_{dvw} - 40$$

where:

- d is the diameter of the fastener, in mm
- ρ_{timber} is the timber density, in kg/m³
- ρ_{dvw} is the dvw density, in kg/m³

The absence of information with respect to the density of the dvw utilised and the timber density was a drawback in most cases. For verification of the mean strength predicting ability of the model the following values were assumed for the dvw: 1200 kg/m³ and for the timber 430 kg/m³.

By substitution of the lower and upper 5% density of dvw and timber in the above equations respective strength predicting boundaries can be given. In Figure 30 the results of this operation are

presented. All data points below the diagonal indicate a safe approximation of the model. The graph covers results of joints with 18, 22 and 35 mm diameter and *d_{vw}* thickness ranging from 8 to 24 mm. There are some deviations but mainly on the safe side.

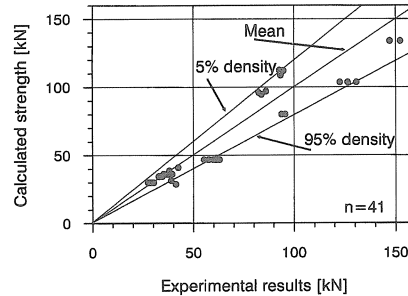

Fig. 30. Strength prediction of the joint per fastener per shear plane versus the experiment.

9 Practical applications

A comparison was made between conventional dowel-type fasteners and the tube joint in four example structures, two portals and two trusses. The main objective was to determine the potential design improvements that could be achieved, especially in terms of timber (costs) savings. The structural analysis for the portal frames was carried out using the computer programme SWANSA the basis of which is explained in more detail by Ragupathy (1994). This programme takes into account material and geometrical non-linearity's and the non-linear semi-rigid behaviour of connections. Further details are given in Leijten (1998).

The following conclusions can be drawn from the analysis:

Without any loss of strength the number of fasteners which traditionally are required can be reduced substantially. In one of the frame corners 38 dowels of 27 mm are replaced by a total of 10 tubes of 35 mm diameter. In the structural analysis of portal frames, conventional joints with dowel-type fasteners often limit the load carrying capacity. The use of *d_{vw}* reinforced joints with tube fasteners not only reduces the number of fasteners substantially, but also improves the performance in terms of strength and stiffness capacity. It was shown that substantial amounts of timber, about 40%, can be saved. This is accomplished by taking full advantage of the ductile properties that the tube joint offers. Plastic design is appropriate provided the design bending moment capacity is reached before the bending capacity of the timber beam is exhausted.

For the trusses indicative conclusions are that the timber members can be made with smaller cross-sections resulting in larger deflections, the savings may be off-set by the deflections. Savings in timber volume of typically 15% are attainable compared to trusses with split ring connectors. Furthermore, the tube joint greatly reduces the complexity of joint design and manufacture.

10 Main conclusions from research

Regarding the cross-wise densified veneer plywood (dvw):

- Dvw is stronger than other types of plywood. The material properties are between tropical hardwood and mild steel except for the modulus of elasticity (Young's modulus) which is similar to hardwoods.
- The embedment strength is correlated with the wood species and density and independent of the grain direction. The use of beech veneers for the production of dvw gave the highest embedment results. For a given density of 1300 kg/m^3 the characteristic (the 5% lower fractile) is 125 MPa independent of the dowel diameter
- The foundation modulus is almost independent with density and load angle to the grain.

Regarding the tube joint with dvw reinforcement.

Using 18 mm and 35 mm diameter tubes with a dvw thickness of 12 mm and 18 mm, respectively and a minimum dvw density of 1300 kg/m^3 the following can be stated:

- The tube joint can be considered as a high capacity joint with respect to strength, stiffness and ductility. With a very limited number of tubes it is possible to design a moment transmitting joint with equal bending moment capacity to that of the timber members.
- The joint behaves isotropic, i.e. there is no load to grain effect for strength and stiffness.
- The joint behaves reliable with respect to strength, stiffness and ductility.
- The minimum end and edge distance is 3.5 times the tube diameter. It will be obvious that smaller distances can be allowed when the dvw thickness is increased. However, at this stage no research is undertaken to investigate this in detail.
- The tube joint has a high energy dissipation capacity and therefore is worth to be considered in seismic active areas.

11 Advantages for Practice

The advantages in practice are considerable:

- All elements of the tube joint are commercially available.
- No new techniques are involved nor special skills.
- The oversized holes makes the assembly of large parts on site much easier.
- The number of holes required is much less than with traditional dowels.
- The drilling precision is less and can be done on site if necessary. The only requirement in the alignment of the holes is to get the tube through.
- Side members thickness can be half the centre or middle member thickness.

- The adhesives used to glue dvw to timber are the familiar structural types well known in glue laminated industry.
- It is mandatory to glue the dvw at the factory unless special precautions are taken.

12 Concluding

In order to overcome the main deficiencies of joints with dowel-type fasteners such as premature timber splitting hole clearance two new elements were introduced. The first is densified veneer plywood (dvw), a very high quality plywood, that is glued to the timber where high concentrated forces caused by the fasteners are expected. The second, the use of a cheap mild steel gas tube which fit into oversized holes and is expanded after assembly of the joint to get a perfect tight fit. As was demonstrated by tests the joint appeared to be very reliable in terms of strength and stiffness with good ductility properties. It can be classified as a high strength and stiffness capacity connection. Besides applied in trusses the tube joint is very suitable for use in portal frames for moment transmitting purposes. It was shown that considerable technical and economical advantages are realised with timber savings up to 30%.

Acknowledgement

The author wishes to acknowledge the industrial partners, Lignostone International (producer of dvw) in Ter Apel (NL) De Groot Vroomshoop in Vroomshoop (NL) and the Firm Holzbau, Brixen (I), both producers of glue laminated structures as well as the European Union for their financial support in this R&D Forest-Project.

References

- JOHANSEN, K.W. (1949) Theory of timber connections, International Association for Bridge and Structural Engineering, nr. 9, p. 249 – 262
- HARDING, N. (1983) Bolted Timber Joints, A Literature survey, Proceedings of the CIB-W18 meeting, Lillehammer, Norway, May / June, paper 16-7-2
- JENSEN, J.L. (1994) Dowel-type fastener connections in timber structures subjected to short-term loading, PhD-thesis, SBI-report 237, Danish Building Research Institute 1994
- JORISSEN, A. J. M. (1998) Double shear timber connections with dowel type, PhD-thesis, Delft University Press, ISBN 90-407-1783-4
- RODD, P.D, SPRIGGS, R.A., HILSON B.O. (1991) Prediction of the embedment characteristics for laterally loaded resin injected bolts in timber, Proceedings of the International Timber Engineering Conference, London, 2-5 sept, Vol.3, p.3.50-3.57.
- LEIJTEN, A.J.M. (1988) Steel reinforced joints with dowels and bolts. In, Proc., International Conference on Timber Engineering Washington State University, Seattle, USA, Sept. 19-22, Vol. 2, pp. 474-488.

- CHEN, C. J. (1992) The study of the mechanical behaviour of wood reinforced with fibreglass, Post graduate study, 1991/1992, Timber Construction, IBOIS, EPFL, Lausanne.
- HALLER, P., CHEN, C. J., NATTERER, J. (1996) Experimental study on Glassfibre Reinforced and Densified Timber Joints, Proceedings of the International Wood Engineering Conference, New Orleans, October 28–31, Vol. 1, pp. 308–314
- LARSEN, H. J. (1996) Glass fibre reinforcement of dowel-type joints, Proceedings of the International Wood Engineering Conference, New Orleans, October 28–31, pp. 293-302
- KEVARINÄKI, A. (1995) Bolt joints of kerto-LVL reinforced with nail plates, Helsinki University of Technology, Laboratory of Structural Engineering and Building Physics, Report 49 HUT/LSEBP, Espoo, ISBN 951-22-2725-9.
- ROGERS, C., THOMSON, R., SMITH, G. (1994) Nailplate Reinforcement of bolted joints, Proceedings of the 1994 Pacific Timber Engineering Conference, July 11–15, Gold Coast Australia, ISBN 1875432 2356, Vol. 2, pp. 349–352
- RODD, P.D. (1996) Locally reinforced moment transmitting joints, Proceedings of the International Wood Engineering Conference, New Orleans, October 28–31, Vol. 2, p. 169–176
- KOLLMANN, F. D. (1955) Technologie des Holzes und der Werkstoffe, Band II, Springer – Verlag, Berlin
- ELHBECK J, WERNER, H, 1992. Embedding strength of densified veneer plywood for dowel-type fasteners, Report of FOREST-project, University Fredericiana Karlsruhe, Department of Timber Engineering
- RODD, P.D. 1993. Embedding strength of densified veneer plywood with dowel-type fasteners, Report of FOREST-project, University of Brighton, Faculty of Engineering and Environmental Studies, Structural Timber Research Unit, U.K.
- BECHTEL F.K. (1986) Use of the Metriguard Model 239A Stress Wave Timer, Metriguard Inc. Pullman, WA, June.
- RIECHERS, K. (1939) Über Verwendung und Prüfung von hochverdichtetem Holz, Holz als Roh- und Werkstoff, 2 Jg. Heft 3, pp. 109-115.
- LEIJTEN, A.J.M, (1998) Densified veneer plywood reinforced timber joints with expanded tube fasteners, Delft University Press, ISBN 90-407-1757-5, NUGI 841.
- CRUZ, H, CECCOTTI, A. Cyclic tests of dvw reinforced joints and portal frames with expanded tubes. Proc. of the International Wood Engineering Conference 1996, Vol. 2, p.447-454.
- KUENZLI, E.W. (1955) Theoretical design of a nailed or bolted joint under lateral load, Forest Products Laboratory, Madison, Wis. (Report D1951).
- RAGUPATHY P. (1994) Analysis of precast concrete subframes with semi-rigid joints, PhD Thesis, Structures Research Centre, Department of Civil Engineering, City University, London.