

Towards a mechanistic analysis of Benkelman beam deflection measurements

Ir. A.F.H.M. Visser

Laboratory for Road and Railroad Research; Faculty of Civil engineering and Geosciences; Delft University of Technology (DUT); Delft

D. Priambodo Koesrindartono M.Sc.

Former student at the International Institute for Infrastructural, Hydraulic and Environmental Engineering (IHE); Delft

This paper introduces and describes the Benkelman beam deflection test. Furthermore Benkelman beam tests are simulated using two multi-layer programs, based on an elastic and visco-elastic material model for asphalt. The results of these two programs are compared with each other. Finally, using the model based on visco-elasticity as a benchmark, the limiting conditions for elastic analysis are indicated.

Keywords: Benkelman beam, visco-elasticity, non-destructive testing, lintrack

1 Introduction

A.C. Benkelman, an employee of the U.S. Bureau of Public Roads, developed in 1953 the so-called Benkelman beam or deflection beam. This device was introduced during the WASHO road test (WASHO: Western Association of State Highway Officials), which was conducted from 1952-1954 in Idaho in the USA [19], [20]. The Benkelman beam (see Figure 1) is a non-destructive portable

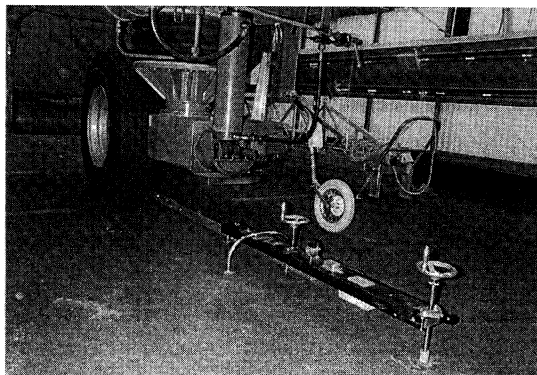

Fig. 1. The Benkelman beam under the LINTRACK.

test-device, which is able to record the pavement surface deflections occurring under actual truck traffic loading at different discrete points along a pavement. The results of these measurements can be used for analysing the bearing capacity of an existing pavement structure and to design the possibly required overlay.

The principle of the Benkelman beam device has produced several offspring [7] of which the (Lacroix) deflectograph (semi-continuous) is a well known one for structural network analysis in the world. At project level the Benkelman beam is hardly used in the Netherlands nowadays, instead so-called Falling-Weight Deflectometer (FWD) measurements are performed. However in major parts of the world (and especially in the so-called developing countries) the Benkelman beam is still the principle device for project as well as network level.

An important drawback when using the device is that most analysis methods of the test-results, like the TRRL-method [14], [8], [9], are empirically based, which can make applications outside the empirical limits at least disputable. Obvious examples of these empirical limits are climate, types of pavement structures, material type and traffic characteristics. Less obvious, but equally important are the geometry of the Benkelman beam, parameters describing the load and load geometry and parameters derived from the measurements [10].

The goal of the research is to come to a mechanistically based analysis procedure of the Benkelman beam deflection test results, useful in especially developing countries.

2 The Benkelman beam deflection measurements

The Benkelman beam consists of two main parts (see for the numbered references the schematic overview in Figure 2).

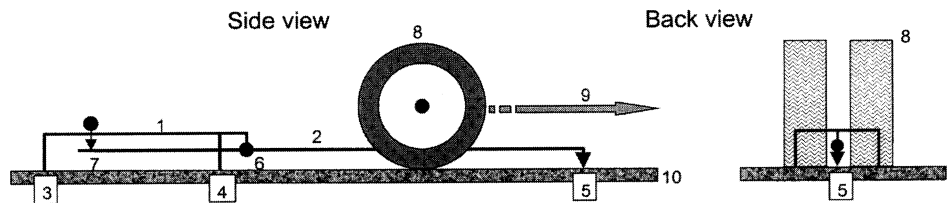

Fig.2. Schematic drawing of the mechanism of the Benkelman beam. Dimensions are in the order of magnitude of: 3-4: 0.9 m, 4-5: 2.7m 7-6:6-5=1:4.

One part (1), the frame, is resting on the pavement and functions as the reference for the measurement; at the backside (3) the frame has one support and at the front side (4) it has two. The other – beam-like – part (2) is connected by a hinge (6) to this reference part and functions as the measuring arm. One end of this measuring arm is resting on the pavement (5), following the actual deflections, while the other end is pushed against the tip of a gauge (7), which actually measures the

occurring deflections. These deflections are generally generated using a normal truck with a known axle loading, tire pressure, dimensions etc. (8). The starting position of the measurements is a non-moving vehicle, with the measuring beam of the Benkelman beam between the tires of one of the dual wheels of the rear axle (the position given in Figure 2). The distance of that part of the beam, which is pushed beyond the axle of the wheel (8) can be different for different measuring procedures, but is about 1 to 1.5 m. The deflections of the tip of the beam are measured, while the truck is slowly driving away (9). For a photographic overview of some stages of the process, see Figure 3.

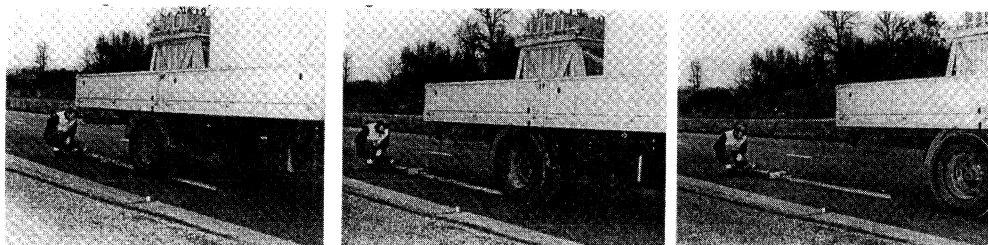

Fig. 3. Photographic overview measurement procedure [8].

The method measures a change in deflection compared to the initial deflection at the start of the measurements. The speed of the truck should be more or less constant and is about 2-3 km/h. In case of the TRRL procedure the lorry is driven at least 3 m beyond the tip (5) of the measuring beam [9]. Another method, applied by the Dutch governmental service for land and water management of the Dutch Ministry of Agriculture, Nature Management and Fisheries [12], is to stop the measurement when no further change in deflection is observed. For practical purposes the vehicle drives a distance of about 10 m. For pavements with a large gradient of stiffness over the depth, it is possible that this 10 m is not sufficient. This method of measurement enables the direct determination of the actual deflection bowl under a slowly moving load, but requires a Benkelman beam with the capability of recording the full deflection bowl. The position of the load with respect to the position of the tip of the measuring beam (5) can be registered, by using a measuring wheel, which is attached to the vehicle.

The measured deflections can be recorded in different ways. The simplest procedure is by eyeballing, in which the only reliable test-data are the maximum deflection and the remaining deflection at the end of the test (TRRL procedure [8]). This maximum deflection is however not considered to be a correct indicator for types of damage occurring due to degeneration of the top layer of a pavement structure. Based on measurements and calculations it has been found that a good correlation can be found between the curvature at the pavement surface and the tensile strain at the bottom of the pavement top-layer [17]. This curvature at the pavement surface is commonly expressed by a 'surface curvature index' (SCI_{xx}), which is defined as the deflection level centrally under the load minus the deflection at a distance 'xx' millimeter from this center. The use of the 'surface curvature' as a critical parameter puts some additional demands to the data-recording system. In this case the standardised recording method as described in the TRRL procedure [8] is not sufficient. Therefore

in this research a Benkelman beam has been used with the capability of recording the full deflection bowl.

3 Actual Benkelman beam measurements using the LINTRACK

To familiarise with the Benkelman beam, a few measurements have been done using the LINTRACK facility. LINTRACK is an accelerated pavement testing facility of the linear type, which simulates heavy traffic [1]. The Road and Railroad Research Laboratory (RRRL) of Delft University of Technology, and the Road and Hydraulic Engineering Division of the Dutch Ministry of Transport, Public Works and Water Management jointly own the LINTRACK. The facility is permanently situated at the outdoor test area of the Road and Railroad Research Laboratory. LINTRACK primarily consists of a dual steel gantry (total length 20 m), along which a loading carriage (see also Figure 1), simulating half an axle, can move forward and backward, see Figure 4.

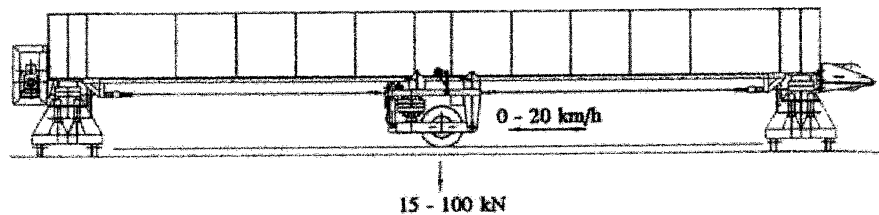

Fig. 4. View of steel gantry and loading carriage.

A dual or wide base single ('super single') truck wheel can be mounted in the bottom part of this loading carriage. For this research a dual wheel has been mounted. The wheel load (adjustable from 15 to 100 kN, i.e. 1.5 to 10 metric tonnes) can be applied by means of pneumatic bellows (somewhat like the air suspension on a truck). The maximum speed is 20 km/h, but lower speeds are possible. In the tests using the LINTRACK facility a speed of 2 km/h has been applied [2]. The applied test-procedure during the Benkelman beam test is the one used by the governmental service for land and water management [12].

To shelter the test sections from climatic influences as rain or sunshine during testing, the entire LINTRACK facility is covered with a hall (23 m long, 6 m wide and 5 m high), which moves with the facility. Furthermore, heating of the asphalt with infrared radiators was implemented in 1997. This enables control of the asphalt temperature during testing, up to about 35°C above ambient temperature. Benkelman beam tests have been done at three different asphalt temperatures, namely 10, 20 and 38°C (meant to be 40°C) at the end of February 2000 [2]. The temperature gradient in the pavement was such that the different materials could be considered to have a constant temperature during the test.

Further information about the pavement structure, which was available at the outdoor test-area and on which the Benkelman beam tests were applied, is given in [5] and [6]. With respect to the layer-thicknesses, the same structure was applied on a recent reconstruction of the motorway A12 near Utrecht in the Netherlands. The pavement consisted of 270 mm of asphaltic material on top of 250 mm of cement bound base (AGRAC), which in its turn was resting on a sand layer of about 5 m thickness. Below this sand layer clayey material is found. The ground water table is about 2 m below the top of the sand layer.

Using the results from FWD measurements together with those of indirect tensile tests, an idea about the stiffness distribution over the layers has been obtained, see Table 1 [6].

Table 1. Indication of stiffness distribution over the layers during Benkelman beam testing expressed as a ratio to the sand subgrade.

Pavement layer	Asphalt temperature		
	10°C ^a	20°C ^a	38°C ^a
Asphalt	40	16	4
Base (AGRAC)	22	16	10
Subgrade (sand)	1 ^b	1 ^b	1 ^b

^a: Rather constant temperature over the thickness of the total asphalt layer.

^b: A value of 250 MPa is appropriate.

A typical test-result obtained during the Benkelman beam tests on this pavement is presented in Figure 5.

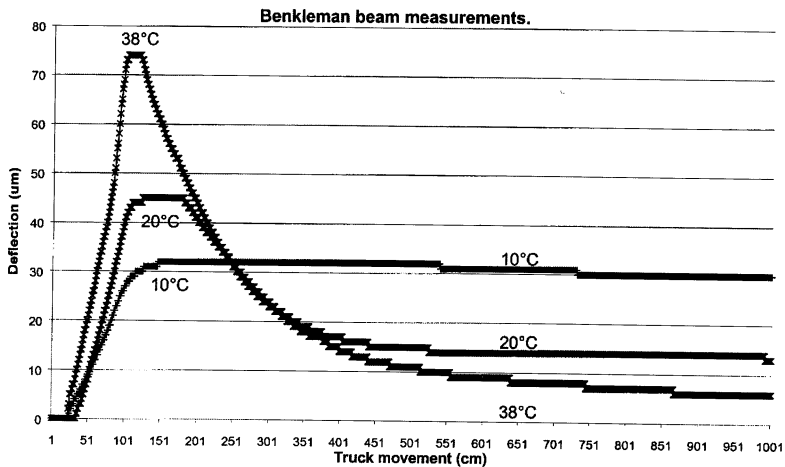

Fig. 5. Benkelman beam test-result under LINTRACK, 57.5 kN dual wheel load.

4 Remarks regarding the starting points for a mechanistic analysis procedure

In choosing an acceptable tool for mechanistic analysis in-practice, linear elastic multi-layer programs are an obvious choice. The advantages of these programs are:

- the little time consumption during application, due to their simplicity in input, together with their analytically based solution, which decreases computational time considerably;
 - the wide availability for reasonable prices;
 - the available experience, which enables relating the outcome to actual pavement behaviour.
- These programs are currently used as the backbone of many mechanistic pavement design and analysis methods, like the Dutch one [4].

An important disadvantage of this type of programs is the used material model. The behaviour of the asphaltic material is largely influenced by temperature and loading time, which cause the material to show creep and visco-elastic behaviour. Due to these effects of the pavements' asphaltic top-layer material, the TRRL method recommends not to do measurements at higher temperatures (30°C as indication, but the level depends on the type of asphaltic material) [9]. Although the test-results are influenced by creep behaviour of the material, this weakness in the Benkelman beam deflection method can possibly be turned over to a strong point. If it is possible to measure this behaviour, the Benkelman beam can be used to measure this behaviour in-situ.

Therefore also another program, VEROAD, has been used. This model is capable of taking the visco-elastic effects into account [18]. This is also an analytically based multi-layer program and it is the proposed backbone for a pavement design method in the Netherlands for flexible pavements (pavements with asphaltic material as the most important structural component) [3]. This program is also capable of taking non-reversible deformations into account.

To take the displacements of the supports into account the full deflection bowl has to be calculated. This enables the transfer of the calculated deflections versus a fixed reference to deflections versus a moving reference identical to the ones in a Benkelman beam test. This transformation is done using Equation 1 and Equation 2 (based on the geometry of the Benkelman beam). The numbers in Equation 1 and Equation 2 refer to Figure 6.

$$md(t) = [w_5(t) - \{(w_4(t) - w_3(t)) \cdot \frac{a+b+c+d}{a+b} + w_3(t)\}] \cdot \frac{b+c}{d} \quad (1)$$

$$rd(t) = md(t) - md(0) \wedge t > 0 \quad (2)$$

$w_3(t), w_4(t), w_5(t)$: pavement deflections at the frame supports and the beam tip.

$md(t)$: gauge reading at time / distance t .

$md(0)$: gauge reading at the start of data-acquisition ($t=0$).

$rd(t)$: gauge reading increment.

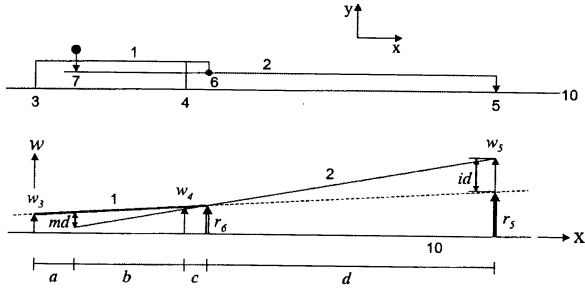

Fig. 6. Geometrical correction for the support movement.

Legend of the indications used in Figure 6, not explained in Equation 1 and Equation 2:

r_5, r_6 : resulting change in reference at important points on the Benkelman beam.

id : deflections in which are actually registered by movement of the beam (nr. 2 in Figure 2)

For a deflection profile calculated with VEROAD, the steps used for transferring the calculations are presented in Figure 7. From Figure 7 it is clear that the absolute level of the deflections is of no importance, as the absolute level is subtracted (see $md(0)$ in Equation 2). The open triangles in Figure 7 are calculated deflections at the surface by means of VEROAD. The open squares represent points on the eventually derived Benkelman beam deflection profile. The dashed lines represent the rotating reference due to the movement of the supports of the frame. The solid lines represent the rotation of the beam. The vertical solid lines with the arrows at the end, with the 'md'-indication behind it are the actually measured values using the Benkelman beam and presented in Figure 7 with the open squares.

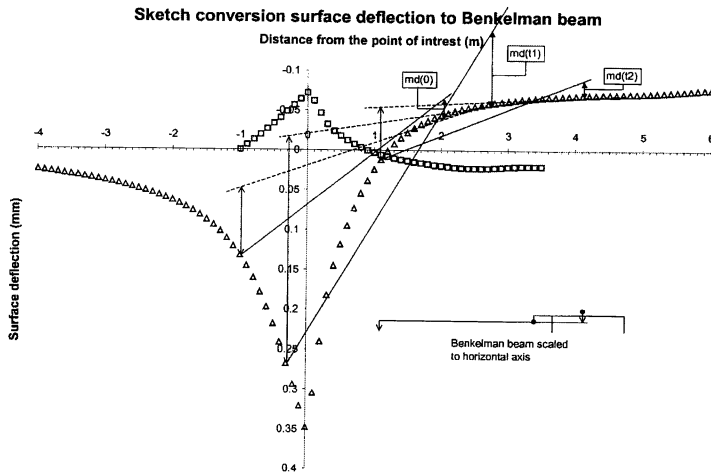

Fig. 7. Conversion of surface deflections to Benkelman beam deflections and the ultimate Benkelman beam profile.

5 Mechanical behaviour of asphaltic materials to describe response

This mechanical behaviour is known to be predominantly dependent on temperature, loading time and stress situation. The currently standard way in pavement modelling is describing the material as elastic, in which case the effects of loading time and stress level cannot be taken into account correctly. One of the models, which can take the time dependent behaviour of asphalt more correctly into account, is the Burgers' model (see Figure 8). This Burgers' model is capable of describing material behaviour under cyclic loading for a limited range of frequencies [21], but it is considered sufficiently accurate to describe the behaviour of asphalt in a pavement under a moving load [22]. The VEROAD program uses the Burgers' model for the description of the time-dependent behaviour of Young's modulus (see A in Figure 8). The Bulk modulus (K) is assumed to behave elastic (see B in Figure 8). Subsequently the shear modulus (G) is also described by the Burgers' model. the implemented material is assumed to behave as an isotropic continuum.

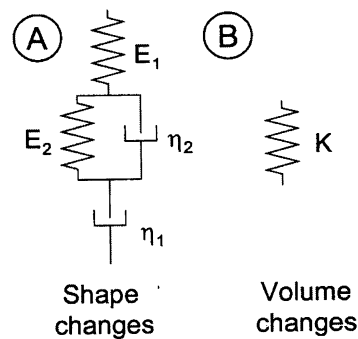

Fig. 8: Material model implemented in VEROAD, A: Burgers' model, B: Linear spring.

The different model parameters for A in Figure 8 can be derived in different ways [2]:

- analysis of results from laboratory tests [21];
- analysing the results obtained by nomographs, furnishing stiffnesses and phase angles [16];
- directly deriving the Burgers' parameters from nomographs [15], [23].

In this research the second option has been followed.

The model parameter for B in Figure 8 can in this case only be derived by estimation, but according to the model it should be time independent. It is also assumed that the behaviour is temperature independent, because this parameter is describing volumetric compression. Assuming a well compacted asphaltic material, which means a lot of stone-to-stone contact, the behaviour of K is predominantly governed by the aggregate in the mix. The mechanical behaviour of the aggregate can be well considered independent of temperature. The authors have used the assumption of a Poisson ratio of 0.15 at such low temperatures that the asphaltic material behaviour is generally considered to be elastic, together with Equation 3 to derive a representative K -value.

$$K = \frac{E}{6 \cdot \left(\frac{1}{2} - \nu\right)} \quad (3)$$

In order to read the used nomographs at the desired conditions, these nomographs had to be extrapolated. This resulted in phase angles, which showed an unrealistic insensitivity for the loading time at the considered temperatures. This in its turn lead to a situation in which the parameters of the Burgers' model could be varied over quite a range, without showing a distinct improvement of the regressional fit of the material model on the nomograph data for the phase angle. The limits of this range of values over which each parameter of the Burgers' model could be varied, were therefore imposed by the correctness of the regressional fit of the material model on the nomograph data for the stiffness values. However the magnitude of the parameters of the Burgers' model, are comparable to the magnitude of the values from experimental results under similar conditions, which were found in literature. Therefore possible errors made with the extrapolations of the nomograph are considered negligible [11]. Further examination of this literature showed that especially the determination of the η_1 -value is under discussion. Depending on the test used, the resulting η_1 -value can differ a factor of 100 for the same material. [11].

It was felt that the influence of this parameter η_1 on the pavement will be the largest for higher temperatures, because the η_1 will govern the larger part of the observed response. Therefore it was decided to fit several models on the available combinations of frequency, stiffness and phase angles for a temperature of 30°C, where the change of η_1 between each model was taken as a constant. The value of η_1 could be varied up till five times the lowest value.

Eventually these exercises lead to input values for the material data, as listed in Table 2.

Table 2. Example of material parameters used for the calculations for two different nomograph temperatures.

	20°C	30°C				
E_{eq}^a (MPa)	1600	500				
E_1^b (MPa)	4100	1700	1455	1500	1450	1500
E_2^b (MPa)	3750	1600	940	600	300	300
η_1^b (MPa·s)	250	40	60	80	120	200
η_2^b (MPa·s)	85	20	30	20	25	23

^a: The equivalent modulus for the elastic calculation.

^b: The Burgers' parameters for the VEROAD program according to Figure 8.

The chosen stiffness values of base (450 MPa) and subgrade (100 MPa) are representative values of 'common' unbound base and subgrade materials.

When considering the equivalent elastic moduli in the tables, it should be noted that these values are quite low when comparing the magnitude of these values with those obtained in triaxial testing as well as stiffness values obtained from in-situ testing. It should be noted that extrapolation of the nomograph data from [16] to the higher temperatures leads to underestimation of the stiffness values of the asphaltic material (see also Table 2). These underestimations are ascribed to a combination of:

- higher temperatures, which causes shifting of the balance from binder to aggregate as the governing component in asphalt behaviour, which causes the material to behave more stress sensitive;
- the predominant tensile stress mode used in the laboratory tests on which the nomographs are based. Unbound aggregates cannot withstand tensile stresses at all and will show their worst mechanical behaviour from a structural point of view;
- the tensile stress mode is not considered to be a correct representative of an equivalent stress situation, when simulating the overall pavement deflection with pavement models, where the used material models are incapable of describing this stress sensitivity.

By calibrating the found moduli from the nomograph to those found for identical materials on in-service pavements for similar temperatures, it is found that the moduli found by the nomograph for 20°C are more representative for in-service temperatures of about 30°C. This causes the values for 30°C to be representative for even higher temperatures. This calibration is based on the 'elastic' modulus, but it is assumed to be equally valid for the parameters of the visco-elastic material model as implemented in VEROAD.

6 The comparison of structural pavement response due to different material models

In Figure 9, Figure 10 and Figure 11 the differences in surface deflections under one of the dual tyres are presented for the model with the elastic top-layer and the one with the visco-elastic top-layer for three different top-layer thicknesses.

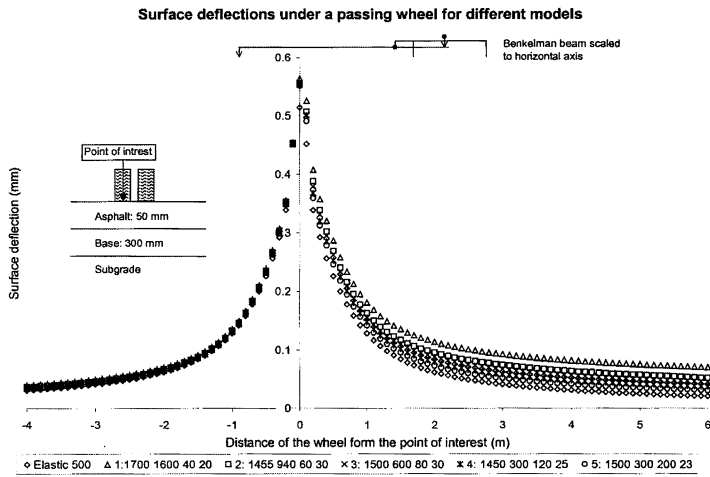

Fig. 9. Surface deflections for a temperature of 30°C and a 50 mm asphalt top-layer under the tyre.

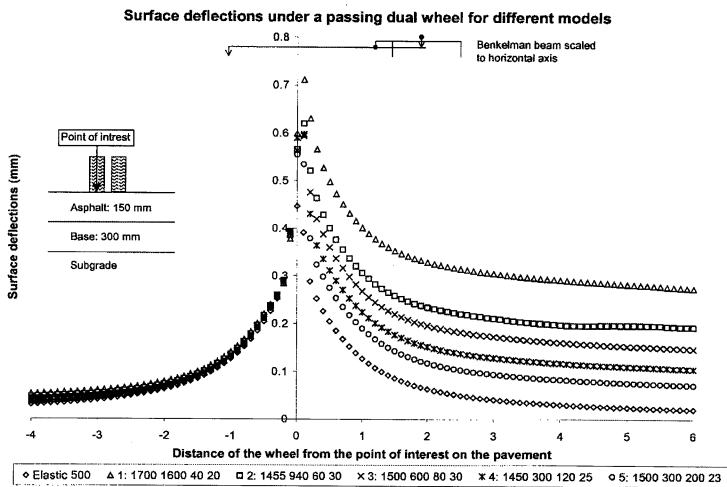

Fig. 10. Surface deflections for a temperature of 30°C and a 150 mm asphalt top-layer under the tyre.

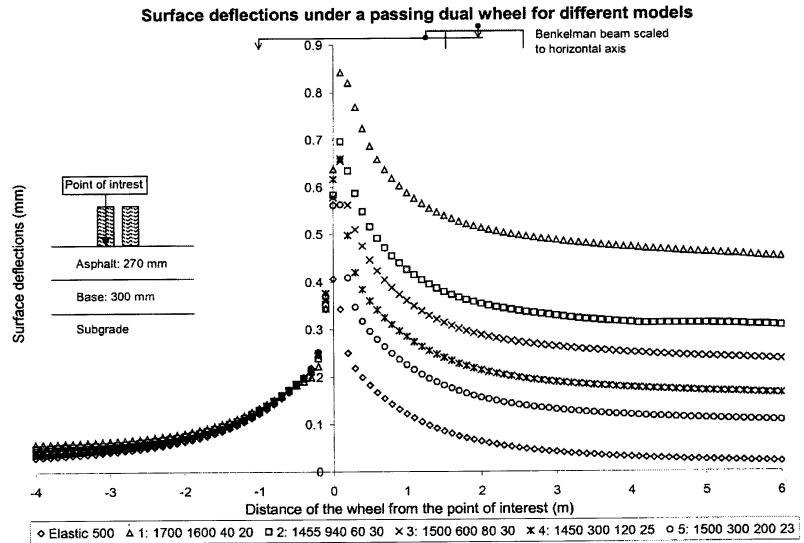

Fig. 11. Surface deflections for a temperature of 30°C and a 270 mm asphalt top-layer under the tyre.

From these calculations four things can be concluded:

- 1) The amount of non-reversible deformation after one wheel passage is unrealistically high. From full-scale test-results it is clear that these values should be a factor 100 to 1000 smaller [6]. These results support the remarks that the stress situation in the test from which the test-results are derived isn't a correct representative of an equivalent stress situation in a pavement. Besides that it is a result of using the Burgers' model, which is only a valid description of asphaltic material behaviour for a moderate time domain. The appropriate times for calculation of permanent deformation are basically outside this time-domain.
- 2) The calculated deflections further away from the arriving load seem to diverge from the elastic solution. This is unexpected as the layers under the top-layer are modeled to behave elastic. The further away the load is from a point on the pavement, the less influence the top-layer will have on the response of the pavement. This behaviour is however ascribed to integration inaccuracies of the calculations, which manifest themselves stronger further away from the load center.
- 3) The influence of time-dependent material behaviour on the deflection is less predominant for a wheel approaching the point of measurement than for a wheel moving away. In order to get insight in the visco-elastic material behaviour measurements are preferably executed according to the procedure of the Benkelman beam and not according to the procedure followed, when using the Lacroix.
- 4) The lower the η_{1r} , the more the response deviates from the elastic solution and the more non-reversible deformation remains after a vehicle passage. It can also be observed that the thicker the asphalt-layer, modeled as the visco-elastic, the larger this permanent deformation.

The presented calculations provide however the response at the position, where the Benkelman beam is unable to measure it. The response is measured between the dual wheels (see the 'back view' of Figure 2). The response of the pavement at this position is presented in Figure 12, Figure 13 and Figure 14.

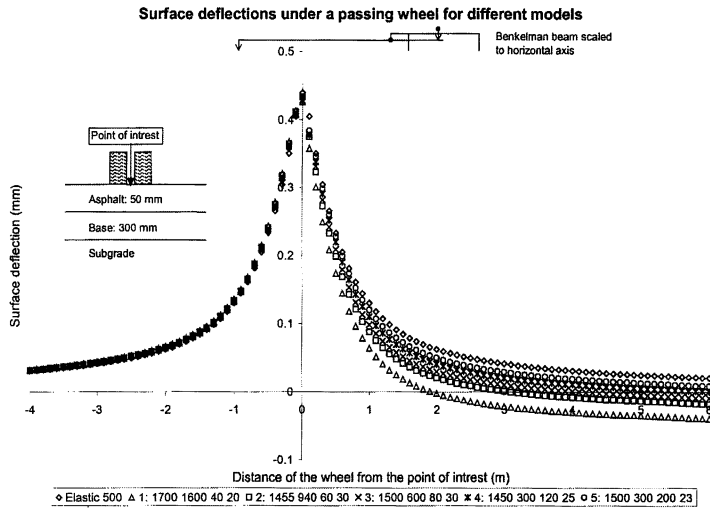

Fig. 12. Surface deflections for a temperature of 30°C and a 50 mm asphalt top-layer between the tyres.

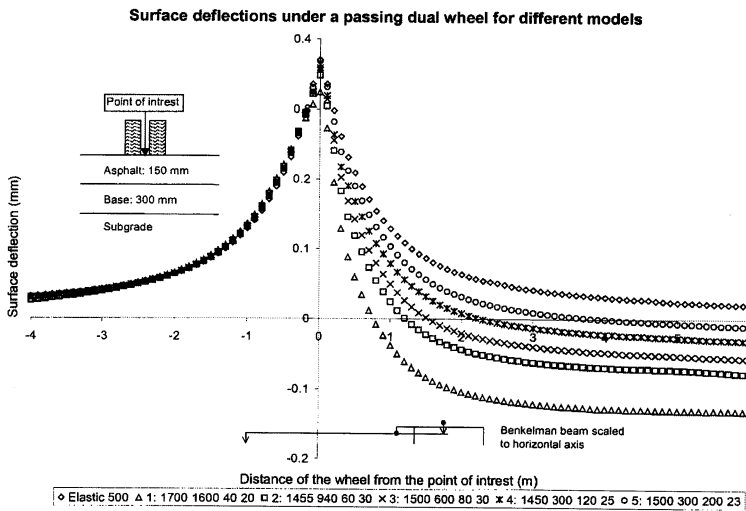

Fig. 13. Surface deflections for a temperature of 30°C and a 150 mm asphalt top-layer between the tyres.

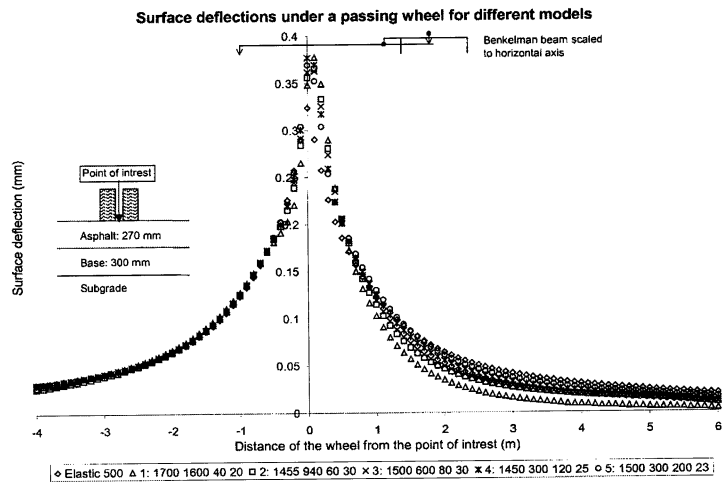

Fig. 14. Surface deflections for a temperature of 30°C and a 270 mm asphalt top-layer between the tyres.

From these calculations the following can be concluded:

- 1) It seems that the sensitivity of the response of the pavement to pavement thickness between the dual wheels is considerably less than under one of the wheels. This difference in behaviour is however for a large part ascribed to the overestimation of the time-retarded response of the asphaltic material, due to the type of laboratory test used to derive the Burgers' parameters. When comparing the elastic results with each other for the different positions under the load, the difference is considerably less.
- 2) The direct relations of:
 - a) a thicker layer lead to a higher value for the non-reversible deformation;
 - b) a smaller η_1 leads to a higher value for the non-reversible deformation;
 seems to be incorrect between the dual wheels. However this would be a false interpretation, because schematically the surface profile of the pavement has moved downward compared to the reference of the initially flat pavement (see Figure 15 for the 270 mm top-layer). This downward movement occurs when the pavement top-layer surpasses a certain pavement thickness.



Fig. 15. Difference in behaviour of the total pavement.

This downward movement can be ascribed to spreading of the load, which makes that deeper within the structure the pavement doesn't feel the dual wheels as separate wheels anymore. So

the upward movement of material between the dual wheel higher in the structure will be counteracted by downward movement of the material deeper in the structure, causing the resulting deformation to be downward for the thicker pavement. (see for a sketch of the mechanism Figure 16)

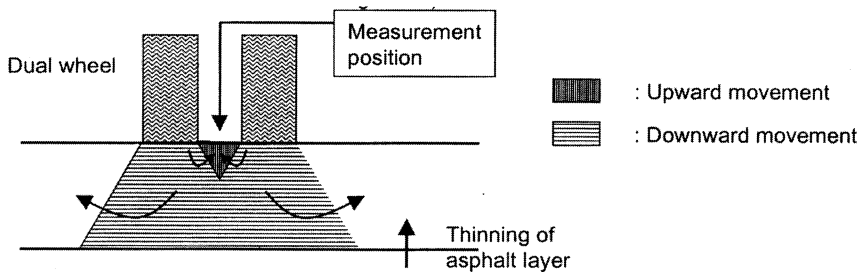

Fig. 16. Schematic explanation of the observed behaviour.

3) In VEROAD a passing wheel is modeled. The load used for the Benkelman beam doesn't pass all positions on the pavement in which one is interested. The load starts moving from a position, which is somewhere between the tip (nr. 5 in Figure 2) and the front support (nr. 4 in Figure 2) of the Benkelman beam (see also the first picture of Figure 2). However the supports are still on the pavement with the asphaltic top-layer showing time-retarded behaviour in loading and unloading. The significance of this behaviour on the movements of the supports can be questioned. If the shape of the deflection bowl further away from the load is not strongly influence by this retarded material behaviour used for the top-layer, than the VEROAD model can still be used for simulation of the Benkelman beam. If the shape of the tail of the deflection bowl is considered, together with the distance at which the supports are positioned from the load-center and it can be concluded that the difference in shape of this part of the deflection bowl calculated using two different material models is quite small, the VEROAD program can be used to simulate Benkelman beam deflections. Due to the small difference in shape of the tail of the deflection bowl, the use of VEROAD – and subsequently the assumption that the wheel passes the supports of the Benkelman beam – in these simulations of the Benkelman beam is considered to be correct.

7 The limits of an elastic analysis of Benkelman beam deflection results

In Figure 17 and Figure 18 some calculation results are presented for the nomograph temperatures of 20°C and 30°C. The thick lines refer to the elastic calculations, while the thinner ones refer to the visco-elastic calculations.

Explanation of some of the indications used in Figure 17 and Figure 18:

- The 'measured surface deflections' along the vertical axis refers to ' rd ', calculated using Equation 1 and Equation 2;

- the indication in the legend refers respectively to top-layer temperature (°C), top-layer thickness (mm) and method of calculation (elastic (no indication) or visco-elastic (a 'v' as indication)).

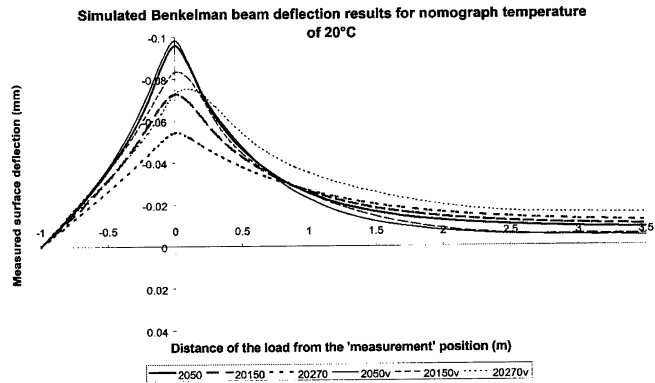

Fig. 17. Simulated Benkelman beam deflection results at 20°C asphalt temperature (explanation of indications used: see at the start of this paragraph).

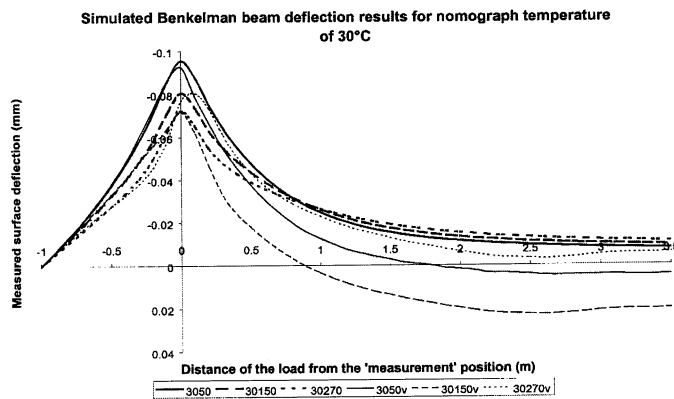

Fig. 18. Simulated Benkelman beam deflection results at 30°C asphalt temperature. (explanation of indications used: see at the start of this paragraph).

The comparison between the elastic and visco-elastic calculations is made using the following indicators (see Table 3 for the numeric results):

- SCI_{500} ;
- Peak deflection;
- End deflection after 3.5 m (arbitrary distance, predominantly expected to be influenced by the subgrade);
- Shape of deflection bowl, indicated by 'Shape' in Table 3 (visually).

Table 3. Numeric results of the chosen indicators of the Benkelman beam deflection bowl.

Asphalt temperature (°C)	Thickness (mm)	SCI ₅₀₀ (µm)		Peak deflection (µm)		End deflection (µm)		Shape
		el ^a	vi-el ^b	el ^a	vi-el ^b	el ^a	vi-el ^b	
20	50	49	50	96	98	8	4	Similar
	150	30	39	73	83	10	5	~
	270	16	27	54	75	12	15	Different
30	50	48	55	96	93	8	-4	~
	150	37	54	81	72	9	-20	Different
	270	33	43	72	80	11	6	Different

^a. Elastic material model

^b. Visco-elastic material model (Burgers')

In the interpretation of the calculation results two things have been taken into account:

- the variability in the measurement results on in-service pavements, due to for instance variability in layer thicknesses, homogeneity of the material over the measurement area, type of transducer and data-acquisition system, etc. Arbitrarily it has been assumed that an error of 4 µm is reasonable. It is also assumed that this error will only have limited influence on the shape.
- the remarks about the calibration of the material data from the experimental situation to an in-service situation as made at the end of the paragraph about 'Mechanical behaviour of asphaltic materials to describe response'.

Based on the interpretation of the calculations Figure 19 is drawn.

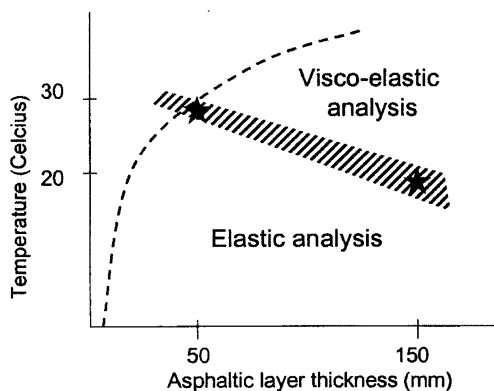

Fig. 19. Conclusions from calculations.

In Figure 19 the combination of asphalt thickness and asphalt temperature are indicated in which an elastic analysis is considered acceptable, by placing the words 'elastic analysis' in this area. For this area two borders are indicated. The hatched area with the two cross-marks in it is based on the calculations presented above. The dashed line is an indication of the existence of a border, which should be ascribed to a significant and measurable influence of stress dependency of the material behaviour. In the area of the lower temperatures this stress dependency is felt due to the large influ-

ence of the base and subgrade on the measured deflection bowl, while in the other area also some effects of stress dependency of the asphaltic material are felt.

The shape and position of the hatched border area are assumed to be significantly affected by:

- the visco-elasticity of the asphaltic material;
- the stiffness of the base material with respect to the stiffness of the asphalt. A stiffer base material will decrease the influence of the visco-elastic top-layer on the deflections and subsequently also the measureability of these effects.

8 Acknowledgements

The Benkelman beam used in the reported research was placed at the University's disposal by ing. A.G. BODE (at that time) of the Governmental Service for Land and Watermanagement of the Dutch Ministry of Agriculture, Nature Management and Fisheries. For this his interest and input in the study he is gratefully acknowledged. Mr. C.H. VOGELZANG of the Laboratory for Road and Railroad Research is thanked for his assistance during the execution of the measurements using the LINTRACK. Prof.dr.ir. A.A.A. MOLENAAR and ir. L.J.M. HOUBEN of the Highway engineering department and ir. A.E. van DOMMELEN of the Road and Hydraulic Engineering Division of the Ministry of Transport, Public Works and Water Management are cordially acknowledged for their critical input and guidance during the research.

9 References

- [1] Accelerated testing and surface cracking of asphaltic concrete pavements; J. GROENENDIJK; Ph.D. thesis; Delft University of Technology, November 1998
- [2] Analysis of Benkelman beam deflection measurements by means of a visco-elastic model; D. PRIAMBODO KOESRINDARTONO; M.Sc. thesis IHE/TU Delft; June 2000
- [3] Geïntegreerd ontwerpen van asfaltmengsels en asfaltverhardingen met COMPASS; Centrum voor regelgeving en onderzoek in de grond-, water- en wegebouw en de verkeerstechniek; Publicatie 140; ISBN 90-6628-309-2; October 1999 (in Dutch)
- [4] Handleiding wegebouw, ontwerp verhardingen; Dienst weg- en waterbouwkunde, Rijks-waterstaat; December 1998 (in Dutch)
- [5] LINTRACK research into rutting of asphalt concrete test pavement 1999/2000; L.J.M. HOUBEN, A.F.H.M. VISSER; A.E. VAN DOMMELEN; DUT/RHED; 7-99-200-28M; June 2000
- [6] LINTRACK research into rutting of asphalt concrete test pavement 1998/1999; L.J.M. HOUBEN, A.F.H.M. VISSER; A.E. VAN DOMMELEN; DUT/RHED; 7-99-200-27M; December 1999
- [7] Niet-destructieve deflectie-metingen aan het oppervlak van wegverhardingen met de Benkelmanbalk of een analoog meetinstrument; J. HAGESTEYN, H. VAN RIJN; Stichting studiecentrum wegebouw; Arnhem; January 1970 (in Dutch)

- [8] Pavement deflection: equipment for measurement in the United Kingdom; C.K. KENNEDY, P. FEVRE, C.S. CLARKE; Transport and road research laboratory; report nr. 834; Crowthorne; 1978
- [9] Pavement deflection: operating procedures for use in the United Kingdom; C.K. KENNEDY; Transport and road research laboratory; report nr. 835; Crowthorne; 1978
- [10] Pavement evaluation and overlay design using falling-weight deflectometers and other deflection measurement devices; A.A.A. MOLENAAR; lecture notes; Delft University of Technology; March 1995
- [11] Personal communications with dr. ir. J. GROENENDIJK; KOAC-WMD; Apeldoorn; July 2000
- [12] Personal communications with ing. A.G. BODE; Dienst Landelijk Gebied; Utrecht; January 2000
- [13] Personal communications with ir. L.J.M. HOUBEN; Delft University of Technology; Delft; June 2000
- [14] Prediction of pavement performance and the design of overlays; C.K. KENNEDY, N.W. LISTER; Transport and road research laboratory; report nr. 833; Crowthorne; 1978
- [15] Prediction of the dynamic visco-elastic behaviour of asphalt wearing course mixes using Burgers' model; A.H. GERRITSEN; Koninklijk Shell laboratorium; AMER.99.001; Amsterdam; March 1998
- [16] Shell pavement design manual, asphalt pavements and overlays for road traffic; Shell international petroleum company limited; London; 1978
- [17] Structural performance and design of flexible road constructions and asphalt overlays; A.A.A. MOLENAAR; Ph.D. thesis; Delft University of Technology; 1983
- [18] The visco-elastic multi-layer program VEROAD; P.C. HOPMAN; HERON, vol. 41, no.1; 1996
- [19] The WASHO road test, Part 1: Design, construction and testing procedures; Highway research board; Special report nr. 18; Washington D.C.; 1954
- [20] The WASHO road test, Part 2: Test data, analysis, findings; Highway research board; Special report nr. 22; Washington D.C.; 1955
- [21] Toepasbaarheid Burgers' model op asfaltmengsels; M.M.J. JACOBS, J.H.M. VERHOEVEN; Laboratorium voor weg- en spoorwegbouwkunde; nr. 7-88-116-4; October 1988 (in Dutch)
- [22] Validation of VEROAD; I. OOST, P.C. HOPMAN; Laboratorium voor weg- en spoorwegbouwkunde; nr. 7-95-118-1; August 1995
- [23] Visco-elastic approach to rutting in flexible pavements; A.C. COLLOP, D. CEBON, M.S.A. HARDY; Journal of transportation engineering, vol. 121, no. 1; ASCE; January/February 1995