

Single fiber pullout from hybrid fiber reinforced concrete

I. Markovich, J.G.M. van Mier, J.C. Walraven

Microlab / Concrete Structures, Delft University of Technology

Hybrid fiber reinforcement can be very efficient for improving the tensile response of the composite. In such materials, fibers of different geometries can act as bridging mechanisms over cracks of different widths. The fiber bridging efficiency depends on the interface properties, which makes interface characterization very important.

Therefore, single-fiber pullout tests from conventional matrices as well as from the fiber reinforced mortar matrices are performed. The composition of the mortar matrix has been varied as well.

The pullout response of single fibers generally improves with increasing percentage of fibers in the mortar. Moreover, pullout forces are generally higher when the matrix has a higher strength. In all these cases, intensive microcracking of the surrounding matrix can be observed during fiber pullout.

Together with single-fiber pullout tests, standard compression tests and splitting tensile tests, as well as workability studies have been performed, in order to provide experimental data for further research of the high-performance hybrid fiber reinforced concrete.

Key words: fiber reinforcement, mix design, mechanical properties, fiber pullout, microscopy

1 Introduction

The weak tensile response of concrete can likely be overcome by application of fibers. Nowadays a wide spectrum of different types of fibers exists, but the application of only one type of fiber in a concrete mixture is still the most common situation. Improvements can likely be achieved by combining different types of fibers in the same concrete mixture. One example is hybrid steel-fiber reinforced concrete [1], [2], which implies short straight fibers and longer fibers with hooked ends.

Combination of short and long steel fibers can enable that each type of fiber may be active in bridging of the cracks of appropriate size. Short fibers can be active in bridging of microcracks in the first stages of the tensile loading, whereas long fibers can activate in the subsequent phases of the tensile loading, when cracks possess larger widths. The pullout process of long fibers is usually accompanied with extensive microcracking within a zone around them. This may suggest that the short fibers can be active also as bridging mechanisms over the microcracks surrounding the large fibers. In this way, the total debonding and pullout response of long fibers may significantly be improved, which reflects directly to the improvement of the tensile properties at larger scales.

On the other hand, the application of fibers is related to the demands for an appropriate design of the concrete mixtures. Such mixtures should have good workability and placing properties, i.e. they should possibly possess self-compacting properties. In addition, concrete mixtures with steel fibers have to be designed in such a way that in the hardened state they can give an optimum response under the action of the tensile stresses. This means that the material of the steel fibers should be utilized up to a certain limit, which is close to the ultimate tensile strength of the fibers.

The experimental program is currently conducted in order to investigate how the presence of short and long fibers and the corresponding mix design govern the properties of concrete in the fresh and the hardened state. Therefore, workability studies as well as compressive and splitting tensile tests were conducted in the first phase of the research. After that, single fiber pullout tests have been performed. These tests are efficient mesoscale-simulations of the debonding and pullout of the fibers, which cross a crack loaded under mode I (Fig. 1). In this case, it should be mentioned that fibers can have different angles of inclination with respect to the direction of the main tensile stresses (Fig. 1b and 1c). Long fibers used throughout the tests were hooked-ends steel fibers. All tests were displacement-controlled.

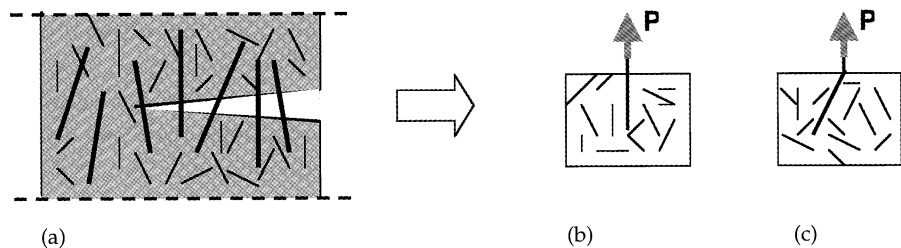

Figure 1. Pullout tests as simulation of the crack bridging by fibers

Single fibers were firstly pulled out from non-reinforced (conventional) mortar. After that, mortars reinforced with one or two types of short straight steel fibers were used as a pullout media. The main goal of the pullout tests was to determine how the complete mix design and the corresponding material properties, reflect to the debonding and pullout response of the single fibers, i.e. to determine the compatibility of the different fiber/matrix systems.

2 Experiments

2.1 Materials and specimens

Throughout this research in total 6 different mortar mixtures were used. The aggregate used is a water-saturated sand with a maximum grain size of 4 mm, and with a grading according to [3]. Portland cement PC I 52.5 R (ENCI) was applied as binder. In this first research phase no fillers were used.

A combination of two superplasticizers (CUGLA LR and HR) with a volume ratio of LR versus HR as 1.5:1.0 was applied in all mixtures. The amounts of superplasticizers had to be adjusted for each particular mixture in advance, in such a way that the fresh mixture possesses a prescribed round slump flow and that no segregation of fibers and aggregate appears. In addition, two different

types of DRAMIX straight high-strength steel fibers (OL 6/.16 and OL 13/.20) were applied in the mortar mixtures during this study. The single fiber in the pullout test, was DRAMIX RC-80/40-BP. It is a fiber with hooked ends, made of high-strength steel (the minimum guaranteed wire tensile strength was 2610 N/mm², [5]). Two mixtures were made without fibers as reference mixtures (mixtures 1 and 4), and the rest contained different amounts of fibers. The water/cement-factor was varied as well. The examined mixtures and the compositions of the reference mixtures are shown in Tables 1 and 2.

Table 1 – examined mixtures

mixture no.	w/c - factor Vol.%	sand Vol.%	fiber OL 6/0.16 Vol.%	fiber OL 13/0.20
1	0.40	30	—	—
2	0.40	26	4	—
3	0.40	24	4	2
4	0.30	30	—	—
5	0.30	26	4	—
6	0.30	24	4	2

Table 2 – reference mixtures (without short fibers)

ingredient	mixture 1*	mixture 4*
cement	923	1068
sand	781	781
water	366	260
superplast.	4.5	64
w/c - ratio	0.40	0.30

*) quantities in [kg/m³], except w/c-ratio in [m/m]

A forced pan mixer has been used throughout the experiments. The following mixing procedure was applied: cement and sand were mixed firstly for 10 s, after which water and superplasticizer were added and mixed for another 1 minute. Thereafter the fibers were added, and mixed for the next 2-3 minutes, depending on the their volume percentage.

From each batch of fresh concrete, 6 cubes (150*150*150 mm) and one special prismatic mould, out of which the cylindrical specimens for the pullout test have been drilled, were filled. The curing regime was the same for all cubes: 28 days at a temperature of 20°C and a relative humidity of 100%. After this period, compressive and splitting tensile tests were performed. The prismatic mould was kept under the same conditions for 21 days, after which the cylindrical specimens were drilled. These specimens were kept for the next 3-4 months at 20°C and at a relative humidity of 90-100%. Fiber pullout tests were performed at the age of 4 - 6 months.

2.2 Test set-up for the single fiber pullout

As mentioned earlier, cylindrical specimens were drilled out from the prismatic mould, after which the single fibers were pulled out of them. During the design of the test set-up for the single fiber pullout, special attention was given to the state of stresses around the fiber, in particular to the possible lateral confinement that could develop as a consequence of the selected boundary conditions. Therefore, a linear elastic finite element simulation has been done in order to determine the optimum design of the test set-up. The common solution with a steel ring on the top as a support of the specimen [4] is not optimal, due to the presence of relatively high arch-like distributed compressive stresses, with maximum values around the fiber hook (Fig. 2). More simple is to glue the specimen directly to the bottom plate, which generates low lateral stresses during the pullout of the fiber. Such test set-up is the most realistic in describing the behavior of a fiber, which bridges an opening crack, and has therefore been used in this research (Fig. 3).

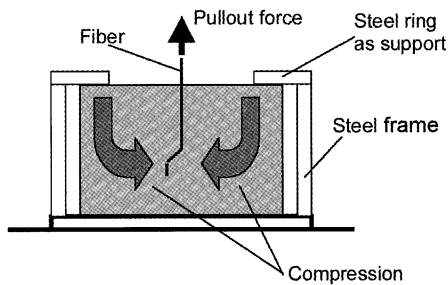

Figure 2. Action of the compressive stresses

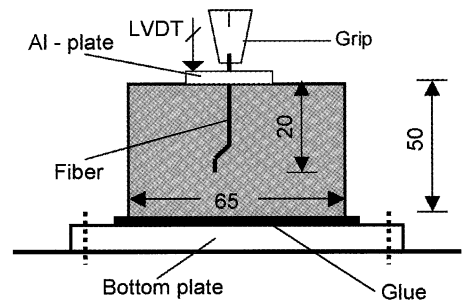

Figure 3. Scheme of the applied test set-up

The diameter of the specimen was 65 mm, and its height 50 mm. Each fiber was embedded 20 ± 0.5 mm in the mortar. A standard INSTRON grip could successfully be applied, even though tested fibers were made of high-strength steel whose hardness is relatively high. For the measurement of the slip of the fiber from the grip, one LVDT (Solarton A6G, linear stroke ± 1 mm) was used. A light aluminium plate, which was fixed to the fiber by means of two small screws, was used as a support for this LVDT. The displacement rate of 5 mm/sec was kept constant during all pullout tests.

2.3 Impregnation procedure

After the fiber was pulled out from a selected cylindrical specimen (mixture 4), vacuum impregnation of the specimen has been done. Fluorescent epoxy resin consisted of low-viscosity epoxy "Conpox Carpiks BY158" and harder HY2996.

3 Results and examinations

3.1 Basic examinations

The workability of the fresh mixtures was determined from the slump flow measurements using a standard 6 liter Abrams cone. The development of the flowable, self-compacting concrete mixtures

was a priority, due to their attractive properties in fresh and in the hardened state. Round slump flow with a diameter larger than 60 cm, without visible grouping and segregation of fibers and aggregate was used as a basic criterion for the self-compactability of the fresh mixtures. A lower w/c -ratio resulted in a better workability. From Fig. 4 it can be seen that it was possible to make self-compacting mixtures without fibers as well as with 4% by volume of the short steel fibers OL 6/.16 (mixtures 1, 2, 4 and 5). The slump flow decreased due to the addition of another 2% longer fibers OL 13/.20 (mixtures 3 and 6), but it was still possible to cast these mixtures properly. The latter two mixtures were additionally compacted on a vibrating table.

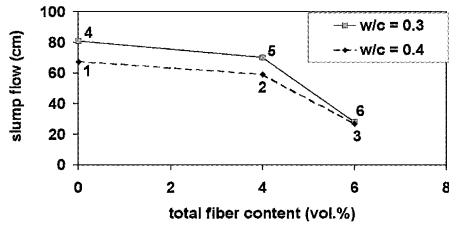

Figure 4. Influence of fibers on workability of the mixtures.
The numbers denote the mixture no., see Table 1

The values of the compressive and splitting tensile strengths are presented in Fig. 5. A slight increase of the compressive strength was observed with an increase of the amount of fibers. The relative increase is much higher in the case of the splitting tensile strength, due to the different mechanisms which lead to the fracture. The highest values were obtained for mortar which contained 6% of fibers by volume and with a water/cement ratio of 0.30. In this case, the compressive strength (119 MPa) was about 6 times higher than the splitting tensile strength (17.5 MPa).

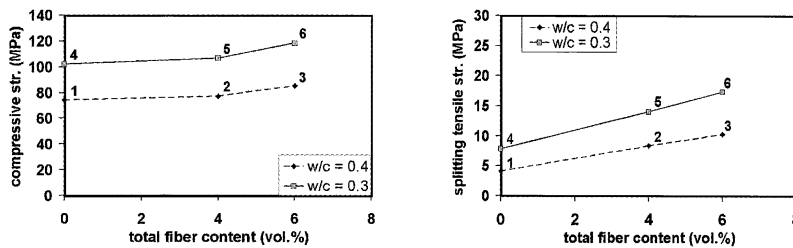

Figure 5. Influence of fiber content and w/c -ratio on compressive and splitting tensile strength

3.2 Results and discussion of the fiber pullout tests

All obtained fiber pullout curves shown a similar appearance (Fig. 6). Firstly, a very short debonding phase between fiber and surrounding matrix takes place. It is followed by a relatively longer phase during which plastic deformation in both curved parts (1 and 2) at the end of the fiber takes place (Fig. 7a and 7b). These two processes form the ascending branch of the pullout curve. After

that, the first part (1) is straightened and it moves in the mortar channel. The second part (2) has to be bent another time, at the place where part 1 used to be in the beginning (Fig. 7c). This corresponds to the second peak on the pullout curve, this time of course with relatively lower value of the pullout force. Afterwards, the hook is almost completely straightened, so that the fiber can move through the original channel without much resistance, generating relatively constant frictional stresses on the contact with the surrounding matrix (Fig. 7d).

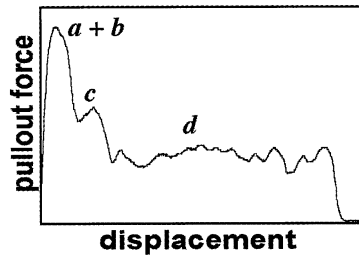

Figure 6. Typical fiber pullout curve



Figure 7. Stages in the plastic deformation of the fiber hook

Twelve series of pullout tests have been carried out in total. The average results of the fiber pullout tests are given in Table 3, where P_{max} is the average maximum pullout force together with its standard deviation (*st.dev.*) and Δ_{peak} is the average corresponding displacement. The average frictional stress is marked as τ_{frict} and it was calculated over the length of 15 mm, which the fiber possesses in the beginning of the frictional stage. Scatter of the measured values was relatively low in all series of the pullout tests, except in the case of fiber pullout from mortar no. 4. The deviations in the pullout response are usually implications of differences in the microstructure of the mortar matrix which surrounds the fiber. The geometry of the hooks can also be slightly different. A standard INSTRON grip was used as a gripping mechanism for the fiber. It was possible to perform about 95% of the tests without significant slip of the fiber from the grip. The minimum and maximum guaranteed tensile strength of the steel wire from which the fibers were made, were 2610 N/mm² and 3090 N/mm² respectively [5]. This corresponds to ultimate tensile forces between 512 N and 605 N. During tensile loading, steel fibers made of such wire are usually strongly gripped at the ends, which generates stress concentrations. As a result, the breaking force of the fibers may be lower than expected on basis of the steel quality.

Table 3: Overview of the performed pullout tests and their results

angle of inclination: 0°						
mixture	w/c	V _{fib} (vol%)	P _{max} (N)	st.dev.	Δ _{peak} (mm)	τ _{frict} (MPa)
1	0.40	0	324.4	(0.9%)	1.25	2.76
2	0.40	4	458.7	(3.9%)	0.95	4.97
3	0.40	6	425.8	(6.4%)	1.10	3.48
4	0.30	0	388.5	(15.2%)	1.08	3.73
5	0.30	4	475.2	(9.2%)	1.05	4.00
6	0.30	6	435.1	(9.5%)	1.12	3.37

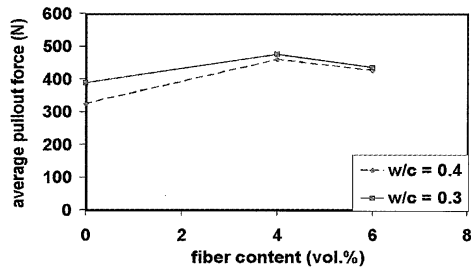

Figure 8. Influence of the short fibers on the pullout force of the long fibers

For the mixtures with a w/c-factor of 0.40, the addition of short fibers (OL 6/.16, 4% by volume) improved the average value of the pullout force by more than 40%. The average value of the frictional stress improved as much as 80%. Addition of more fibers (another 2% of OL13/.20 by volume), did not result in further improvement of the pullout behavior. Values of the pullout forces and frictional stresses were even lower than for the mixtures with short fibers only. The fibers had thus much better performance when they were pulled out from mortars which were self-compacting in the fresh state (see Fig. 4). Typical pullout curves are presented in Fig. 9.

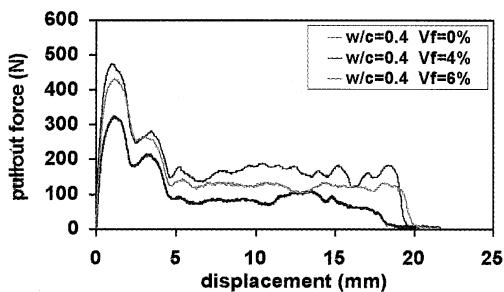

Figure 9. Fiber pullout curves from the mortars 1, 2 and 3

Decreasing the w/c-ratio had a positive effect on the pullout behavior. The addition of 4 volume percent of short fibers (OL6/.16) resulted here in an improvement of the pullout force of about 25%, compared to the non-reinforced mortar. The frictional stress increased slightly as well. Similarly as before, the application of more fibers (another 2 vol. % of OL13/.20) did not lead to the further improvement of the pullout behavior. Such performance seems to be related to the workability in this case as well. Typical pullout curves from the mortars with w/c=0.3 are presented in Fig. 10.

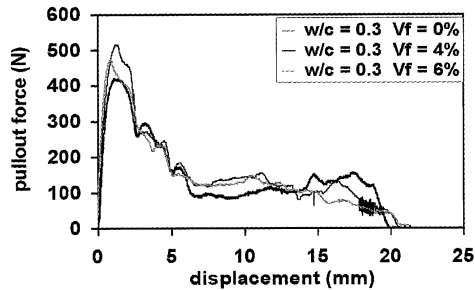

Figure 10. Fiber pullout curves from the mortars 3, 4 and 5

3.3 Microstructural observations

After hardening of the epoxy, the specimen (mixture 4) was cut along the fiber axis in order to observe the microstructure of the material after the fiber was pulled out. These mortars are generally rather dense and epoxy can not penetrate more than 1 - 2 mm from the exposed surface. However, the deep channel from which the fiber was pulled out is very suitable for the impregnation, because epoxy can actually penetrate as deep as the fiber embedment length used to be.

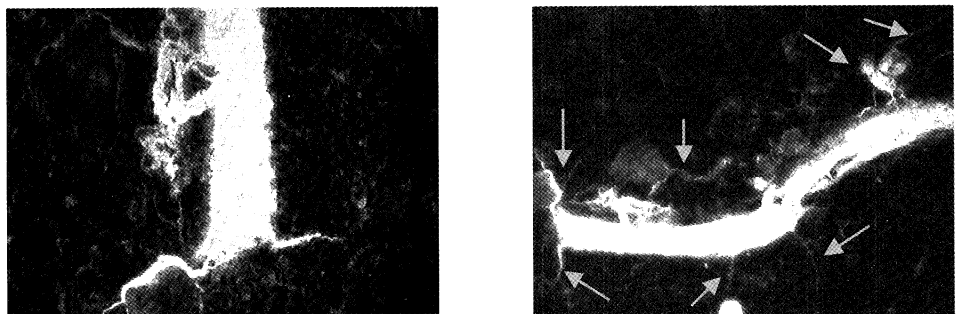

Figure 11. Intensive microcracking processes around the fiber hook

Observations showed that significant microcracking within an approximately 1.5 mm wide zone around the fiber took place (Fig. 11). Many cracks appeared in a zone around the fiber hook. Cracking was registered at the straight part of the channel as well, but to a less extent. In addition to that, several very fine round pores were observed (average diameter around 0.1 mm). The epoxy did not penetrate more than 1.5 mm within the zones where extensive cracking took place, which suggests that the density of this mortar is quite high. It may be assumed that the similar phenomena occur in mortars which are reinforced with short fibers. This suggests that short fibers may be active as bridging mechanisms over existing microcracks, which results in a further improvement of the fiber pullout response.

4 Conclusions

Experiments with different conventional and fiber reinforced mortars were performed. Firstly basic properties, such as workability, compressive and splitting tensile strength, were determined. After that, single fiber pullout tests from conventional and fiber reinforced mortars were carried out. This was accompanied with observations of the microcracks, which develop around the fiber during its pullout. On the basis of the results obtained, the following conclusions can be drawn:

1. Mortars with lower water/cement-factor (0.30) had a better total performance than those with a higher w/c-factor. This conclusion relates to the single fiber pullout tests as well as to the basic properties.
2. The addition of 4% by volume of short fibers OL 6/.16 resulted in a further improvement of the material performance. These fibers played a beneficial role especially in the case of the mortars with a w/c-factor of 0.40, where the average single fiber pullout force increased about 40% compared with the non-reinforced mortar.
3. Microstructural observations showed that during the pullout process, intensive microcracking occurs around the fiber. Short fibers probably act as bridging mechanisms over these cracks, so that the total pullout response can significantly be improved.
4. Mortars in which another 2% by volume of longer fibers OL 13/.20 were added, did not show better total performance than those with 4% of short fibers only. The workability was not satisfactory, which could result in a larger porosity around the single fiber. This may be a possible reason that the pullout response was not improved.
5. Pullout of the same fibers (RC-80/40-BP) from mortars with even lower w/c-factors and addition of short fibers and filler materials will probably result in fiber fracture, because bond can not be improved endlessly. It may therefore be concluded that larger fibers can be successfully implemented in such mixtures.

Acknowledgements

The research project "Development of the high-performance hybrid fiber concrete" is a part of the Dutch STW/PPM program "Cement-bonded Materials", DCT 4001 III.d. The steel fibers used in these experiments were sponsored by BEKAERT N.V., Belgium.

Mr. A. Elgersma is gratefully acknowledged for his expert help in performing the pullout tests. The author is also thankful to H. Janssen, Th. van Soest and R. Mulder for their cooperation during this research.

References

- [1] Y. Sato, J.G.M. van Mier, J.C. Walraven: Mechanical characteristics of the multi-modal fiber reinforced cement based composites, Proceedings of the 5th International RILEM Symposium, BEFIB 2000, pp. 791-800 (2000).
- [2] P. Rossi, S. Renwez: High performance multimodal fiber reinforced cement composites, Proceedings of the 4th International Symposium on utilization of high strength/high performance concrete, pp. 687-694 (1996).
- [3] S. Grünwald, J.C. Walraven: Self-compacting fiber reinforced concrete, Stevin-report 25.5-00-11, Delft University of Technology, the Netherlands (2000)
- [4] A. van Gysel: Study of the pullout behavior of steel fibers inbedded in cement-bonded matrix with application on the fiber reinforced concrete in bending, PhD-thesis, Laboratorium Magnel voor Betononderzoek, Faculty of Applied Sciences, University of Gent, Belgium (2000) (in Dutch)
- [5] Dramix® - Steel wire fibers for the reinforcement of concrete and mortar, Bekaert product information (2000) (in Dutch).