

Load Sharing in Insulated Double Glass Units

Determination of the air pressure in the cavity due to mechanical and thermo-mechanical loads.

E.M.P. Huveners, F. van Herwijnen and F. Soetens
Eindhoven University of Technology, Eindhoven, The Netherlands

Glass is an indispensable building material because of the special properties. Glass has a low heat resistance and therefore it is a thermal leakage in the outer wall. Insulated double glass reduces the heat transfer tremendously. The closed air in the hermetically closed cavity is a good insulator. The magnitude of the pressure in a hermetically closed cavity is an unknown parameter. What is the cavity pressure if the temperature changed, ambient pressure changed, under a uniformly distributed load, under a concentrated load and the like? These influences were investigated by an analytical model and were verified by experimental research.

Keywords: Glass, insulated double glass unit, hermetically closed cavity, load sharing.

1 Introduction

Glass was and is an indispensable building material. Normally, glass is used as transparent element in façades and roof structures. Beside architectural and physical requirements, glass has to comply with structural requirements. The present Dutch codes describe design rules for single glass, laminated glass and insulated double glass, which are two, three or four-sided supported. The load is only uniformly distributed load. For every type of glass, an ultimate bending stresses is defined which depends on duration (short, medium and permanent).

Unfortunately, the present Dutch codes are very brief. For other cases, no design rules are available such as design rules for concentrated load, linearly distributed load, climate loads, point fixed glazing and so on. Another problem is the simplification of the design rules to avoid complex calculations. In only some cases, the simplifications are justified.

Insulated double glass can be calculated with equivalent thickness in conformity with the present codes. For other cases than uniformly distributed load the response of the insulated double glass is very complex. The complexities are the behaviour of thin glass panes, cavity, sealant around the edges and supporting structure.

The objective of this graduation project was to get more insight in the behaviour of insulated double glass. An analytical model was developed for four-sided insulated double glass. After a parameter study, the analytical model was verified partly by an experimental research. To explain the

deviation in the results of the experimental research with the analytical model both glass panes were modelled in a finite element program. In this article a summary of the approach and the outline of the results are given.

2 Glass as structural material

Glass has been used by human beings for many centuries. At the beginning only for utilities like bowls and dishes, later as building material. The property of transparency makes it special. Nowadays, glass is also used as structural material. Glass behaves in a crucially different way from other, more familiar, structural materials like steel and timber. It does not yield, it fractures and its failure is stochastic. The fracture energy is very low, namely 1 J/m^2 , in comparison with that of steel, namely 10^6 J/m^2 . It behaves perfectly linear elastic up to the moment it fractures. The intrinsic strength of glass is very high. In tension, a value of 10.000 N/mm^2 can be kept on, and in compression, even a value 10 times higher. Unfortunately, in engineering practice it is not allowed to use these high values of intrinsic strength in calculations, because glass always shows defects, not only on the surface but also at the edges, acting as stress concentrators, developing existing cracks resulting in failure. For this reason, the design strength of glass is about one percent of the intrinsic strength.

Table 1: Typical composition of soda-lime-silica-glass.

Component	Chemical designation	Amount in percents
Silica	SiO_2	70-74
Lime	CaO	5-12
Soda	Na_2O	12-16
Magnesium, aluminium, iron and other elements are the remaining components.		

The composition of glass varies with the manufacturer, but is generally as shown in table 1. Glass is a hard, brittle, transparent material, obtained by melting sand and lime, usually mixed with other materials, like soda, to improve the properties. The glass phase is a special phase of a material, originated by a fast cooling down of a liquid, passing the solidification point without crystallization into a solid. Glass can be considered as a super cooled liquid with a high viscosity.

The typical properties of glass are summarized in table 2. The float glass process, invented by Pilkington, makes it possible to produce very flat glass sheets, with a thickness of 0.2 to 19 mm and a size of maximum 3.2×6.0 square meters. This semi-finished product can be improved to (thermally or chemically) toughened glass, laminated glass or insulating glass units. The next paragraphs deal only with insulating glass units.

Table 2: Typical properties of glass.

Properties	Soda-lime-silica glass
Density	2500 kg/m ³
Young's modulus	70.000 N/mm ²
Poisson ratio	0.23 -
Coefficient of thermal expansion	9 · 10 ⁻⁶ K ⁻¹
Thermal conductivity	0.93 W/(mK)
Specific heat	840 J/(kgK)

3 Present Dutch standards

At this moment there are several National Standards dealing with glass as building and structural material, applicable in the Netherlands:

- NEN 2608: Glass in building – Resistance against wind load – Requirements and determination method.
- NEN 2608-2: Glass in building – Glazed installations non-vertical installed – Resistance against wind load, snow load, and self-weight - Requirements and determination method.

In the near future there will be also a European Standard: CEN/TC129/WG8; Draft for Design of Glass Panes, part 2: Design of Uniformly Distributed Loads.

The present glass standards dealing with glass structures are still in their initial stage compared to the standards for other structural materials. They have a limited content and do not always provide answers on questions from structural engineering practice.

The standards give design rules for single glass, laminated glass and insulated glass. They consider rectangular glass panes, which are two, three or four-sided simply supported under uniformly distributed loads. The theoretical base is geometrical and physical linear plate behaviour. The ultimate tensile strength for bending depends on the type of glass and the load duration (see table 3).

Table 3: Time-dependent representative ultimate tensile strength for bending ($f_{nt,w,rep}$) of annealed glass in the Netherlands, according to [4] and [5].

- (1) in case of dead load by own weight (long term) acting on a pane in a non-vertical position.
- (2) in case of dead load (long term) and snow load (medium long-term) acting on a pane in a non-vertical position.
- (3) in case of dead load (long term) and wind load (short-term) acting on a pane in a non-vertical position. In case of vertical position, only wind load is considered.
- (4) NEN 2608 only prescribes the value $f_{nt,w,rep} = 50 \text{ N/mm}^2$.

Type of glass		Load duration	Dead load ⁽¹⁾	Dead load and static live load ⁽²⁾	Dead load and dynamic live load ^(3,4)
Float glass	Normal		17.4	23.1	46.2
	Heat strengthened		47.1	52.8	75.9
	Thermally strengthened		106.1	111.8	134.9
	Chemically strengthened		141.4	147.4	170.9
Enamelled glass	Heat strengthened		17.4	23.1	46.2
	Thermally strengthened		52.8	58.8	81.9
Cast patterned glass	Normal		13.6	18.2	36.2
	Heat strengthened		22.6	27.2	45.5
	Thermally strengthened		54.4	59.0	77.0
	Chemically strengthened		108.8	113.4	131.4
Wired glass	Patterned glass		9.8	13.1	26.1
	Wired glass		13.6	18.2	36.2

As already stated the glass regulations are in motion and table 3 is already superseded. The present glass regulation gives formulas with the following parameters: glass strength properties, the finish of the edges, crack behaviour and time duration. Nevertheless, the values in table 3 gives an indication of the magnitude of several types of glass with three time durations.

In case of laminated glass the glass panes are glued together by a PVB interlayer, and act together in case of loads perpendicular to the surface. In case of insulating glass units, load acting inwards on the outer pane, will compress the air cavity and increase the pressure of the air in the cavity. This pressure acts outwards as load on both the outer and the inner pane. Due to the air cavity, load sharing acts on outer and inner glass pane.

For simplicity of the analysis, the different glass panes in laminated and insulated glass units are represented by one pane with an equivalent thickness. This is permitted since the deformations of the distinct glass panes are congruent. The equivalent thickness is needed for determining the maximum tensile stress acting in the glass unit according to linear elastic mechanics.

$$t_e = t_1 \sqrt{\left(\frac{t_1^3 + t_2^3}{t_1^3} \right)} \quad \text{and } t_1 \geq t_2 \quad (1)$$

Wherein:

t_e is the equivalent thickness in mm

t_1 is the thickness of pane 1 in mm

t_2 is the thickness of pane 2 in mm

For laminated glass the creep behaviour and the temperature sensitivity of the polyvinyl butyral interlayer is also involved by this formula, namely no collaboration between the glass panes (no shear transfer).

The Dutch glass standards only consider uniformly distributed loads. Other load cases, like linearly distributed loads, concentrated loads and dynamic loads are not mentioned. For non-rectangular glass panes, or point supported glass units, the present standards are not valid.

In addition, climate loads, like changes of ambient temperature and atmospheric pressure, are not considered. These loads have a large influence on the air pressure in the cavity of the insulated double glass units and cannot be neglected. Even type of loading has an influence on the deformation characteristics of outer and inner pane in insulated double glass units. In case of a concentrated load, the deformation of the outer pane depends on the position of this load. The deformation of the inner pane is caused by a uniformly distributed load, as a result of the increase in air pressure in the cavity. Therefore the deformation of the outer and inner pane is not congruent, and the design rules of the Dutch standards using an equivalent thickness for the panes are no longer valid.

To get more insight in load sharing of double glass units under non-uniformly distributed loads, an analytical and experimental research has been carried out.

4 Research on load sharing of insulated double glass units

4.1 Aim of the research

The aim of the research was to get a better insight in the load sharing of insulated double glass units, by determining the pressure of the air in the cavity under mechanical and climatic loads. The analytical and experimental research focuses on four-sided simply supported units. The numerical research was carried out for visualizing the plate behaviour and for explaining the results of the experimental research.

4.2 The interaction between air cavity and panes

The glass panes can be modelled as plates with geometrical and physical linear plate behaviour. In between these plates there is a certain amount of gas, hermetically trapped when sealed insulating

units are manufactured. The cavity pressure can be calculated using Boyle's Law or the General Gas Law:

$$P_{e;(R_m, T, V)} = \frac{nR_m T_e}{V_e^{TH}} \quad (2)$$

Wherein:

P_e is the absolute cavity pressure in Pa (N/m²)

n is the amount of material in mol

Definition mol:

One mol is the amount of material which contains equally elementary entities as are present atoms in 0.012 kg Carbon.

R_m is the molar gas constant in J/(mol·K)

The magnitude of this constant is about 8.31451070 J/(mol·K).

T_e is the absolute temperature in K

V_e^{TH} is the volume according to the general gas equation in m³

The amount of material in the cavity decreases after the hermetically closing of the cavity from the ambient atmosphere. Because of the desiccants in the hollow spacer tube, separating the glass panes, withdraw water vapour from the cavity. Therefore, the initial cavity pressure is a slight underpressure (see figure 2).

The product $n R_m$ remains constant (c). The equilibrium temperature is determined arbitrary in the considered state of equilibrium:

$$V_e^{TH} = \frac{cT_e}{p_e} \quad (3)$$

The last unknown parameter in the considered state of equilibrium is the volume. This can be calculated by superposing the changes of volume to the initial volume. The change of volume can be calculated by integration of the deformations of the plate under loading in two orthogonal directions.

$$\Delta V = \int_0^a \int_0^b w_{(x,y)} dx dy \quad (4)$$

Wherein:

ΔV is the change of volume in m³

$w_{(x,y)}$ is the deformation function of the plate in m

$$w_{(x,y)} = \frac{16F_0}{\pi^6 \alpha \beta K} \sum_{m=1,3}^{\infty} \sum_{n=1,3}^{\infty} \frac{\sin \frac{m\pi x_F}{a} \sin \frac{n\pi y_F}{b} \sin \frac{m\pi \alpha}{2a} \sin \frac{n\pi \beta}{2b}}{mn \left(\frac{m^2}{a^2} + \frac{n^2}{b^2} \right)^2} \sin \frac{m\pi x}{a} \sin \frac{n\pi y}{b}$$

- a is length of the glass plate in m
- b is width of the glass plate in m

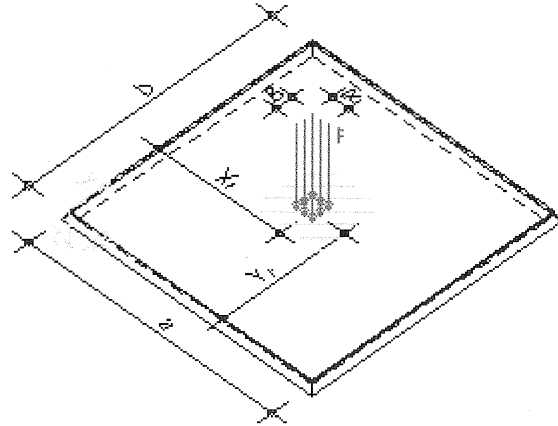

Figure 1: Concentrated load on the glass pane.

In general, a load surface of $\alpha \times \beta$ is considered, as concentrated load (see figure 1). In case $\alpha = a$ and $\beta = b$, the plate is uniformly distributed loaded.

$$\Delta V = \frac{768(1-\nu^2)F_0ab}{\pi^8\alpha\beta Et^3} \sum_{m=1,3,\dots}^{\infty} \sum_{n=1,3,\dots}^{\infty} \frac{\sin \frac{m\pi x_F}{a} \sin \frac{n\pi y_F}{b} \sin \frac{m\pi\alpha}{2a} \sin \frac{n\pi\beta}{2b}}{(mn)^2 \left(\frac{m^2}{a^2} + \frac{n^2}{b^2} \right)^2} \quad (5)$$

Wherein:

- F_0 is the concentrated load in N
- a is the length of the plate in m
- b is the width of the plate in m
- α is the length of the load area in m
- β is the width of the load area in m
- x_F, x_F' is the coordinate of the center of gravity of the load over the length (a) in m
- y_F, y_F' is the coordinate of the centre of gravity of the load over the width (b) in m
- E is the Young's modulus in N/m²
- ν is the Poisson ratio [-]
- t is the (equivalent) thickness of the glass plate in m
- m is the numerical natural number, with the exception of zero, belonging to length a [-]
- n is the numerical natural number, with the exception of zero, belonging to width b [-]
- ΔV is the change of volume in m³

All parameters of the deformation function are known, namely the length, the width, the plate stiffness and the type of loading (uniformly distributed, concentrated or linearly distributed load).

Because the General Gas Law considers the absolute pressure, the variable atmospheric pressure and the cavity pressure are regarded as uniformly distributed loads on the panes. The first leads to constant b , the second to constant a multiplied by the unknown cavity pressure p_e according to equation (6):

$$V_e^M = ap_e + b \quad (6)$$

$$\begin{aligned} b &= V_b - V_{dw;top} + V_{dw;bottom} - V_{st;top} - V_{wl;top} + V_{wl;bottom} - V_{al;top} \\ &\quad - V_{cl;top} - V_{ll;top} - V_{p_a;top} - V_{p_a;bottom} \\ ap_e &= V_{p_e;top} + V_{p_e;bottom} \end{aligned} \quad (7)$$

Wherein:

V_e^M	is the final volume in m^3
V_b	is the initial volume in m^3
$V_{dw;top}$	is the change of volume of the top plate as a result of its dead weight in m^3
$V_{dw;bottom}$	is the change of volume of the bottom plate as a result of its dead weight in m^3
$V_{st;top}$	is the change of volume of the top plate as a result of a snow load in m^3
$V_{al;top}$	is the change of volume of the bottom plate as a result of a live load in m^3
$V_{wl;bottom}$	is the change of volume of the bottom plate as a result of a wind load in m^3
$V_{wl;top}$	is the change of volume of the top plate as a result of a wind load in m^3
$V_{cl;top}$	is the change of volume of the top plate as a result of a concentrated load in m^3
$V_{ll;top}$	is the change of volume of the top plate as a result of a line load in m^3
$V_{p_e;top}$	is the change of volume of the top plate as a result of cavity pressure in m^3
$V_{p_e;bottom}$	is the change of volume of the bottom plate as a result of cavity pressure in m^3
$V_{p_a;top}$	is the change of volume of the top plate as a result of actual atmospheric pressure in m^3
$V_{p_a;bottom}$	is the change of volume of the bottom plate as a result of actual atmospheric pressure in m^3

The following sign convention is used: a negative sign in the formula means a decrease, and a positive sign means an increase of volume with respect to the initial volume.

Equalization of equation (6) and (3) results in the unknown cavity pressure p_e :

$$\begin{aligned} V_e^M &= V_e^{TH} \\ ap_e^2 + bp_e - cT_e &= 0 \end{aligned} \quad (8)$$

The quadratic equation (8) results in two mathematical solutions, however only one solution has a physical relevance (see formula 9).

$$p_e = \frac{-b + \sqrt{b^2 - 4ac}}{2a} \quad (9)$$

The absolute pressure p_e subtracted with the present ambient pressure p_a is the effective cavity pressure p_{eff} , which will load both glass panes.

4.3 The influence of the stiffness of the panes on the cavity pressure

The stiffness has an important influence on the magnitude of the changes in volume. The plate stiffness depends on:

- the glass thickness;
- the boundary conditions;
- the size of the pane;
- the location of the non-uniformly distributed load;
- the response of the plate.

Making a glass pane two times thicker, the stiffness will increase by a factor of eight. Fixed edge supports result in a stiffer behaviour of the pane, compared with hinged edge supports. The smaller the size of the pane, the stiffer the pane will behave. The location of a concentrated load plays an important role. For instance, a concentrated load in the middle of the plate results in larger deformations than the same load near the supports.

A special point of attention is the response of the glass pane. In analytical analyses, geometrical and physical linear behaviour of the plates is assumed. The current Dutch codes use these assumptions too. The physical linear behaviour is always true, but the geometrical linear behaviour depends on the magnitude of the deformation. Glass panes are normally very thin plates with large size, which will deform easily. Thus, the deformations are also large compared with the thickness of the pane. This results in geometrical non-linear behaviour introducing membrane stresses, and smaller deformations. The plate gets stiffer due to this "plate behaviour".

4.4 The influence of loading on the cavity pressure

As stated before, the stiffness of the plates plays an important role in the magnitude of the cavity pressure. Loads are needed for changes in volume. Two loads categories can be distinguished, namely mechanical and thermo-mechanical loads. Mechanical loads are uniformly distributed loads, line loads and concentrated loads on the outer and inner glass pane of the double glass unit. Thermo-mechanical loads are related to the amount of material in the cavity (water molecules), the atmospheric pressure and the temperature of the ambient air.

4.4.1 Thermo-mechanical loading

There are three main types of thermo-mechanical loading for insulated double glass units, namely change in relative humidity, atmospheric pressure and temperature. All these thermo-mechanical

pressures result in the effective cavity pressure, acting as uniformly distributed load on the cavity side of both panes.

The air between two very stiff glass panes (see figure 2) causes a very large change in cavity pressure in case of changes in relative humidity in the cavity. The stiffer the glass panes, the smaller the compensation in change of volume will occur, thus the higher the effective cavity pressure.

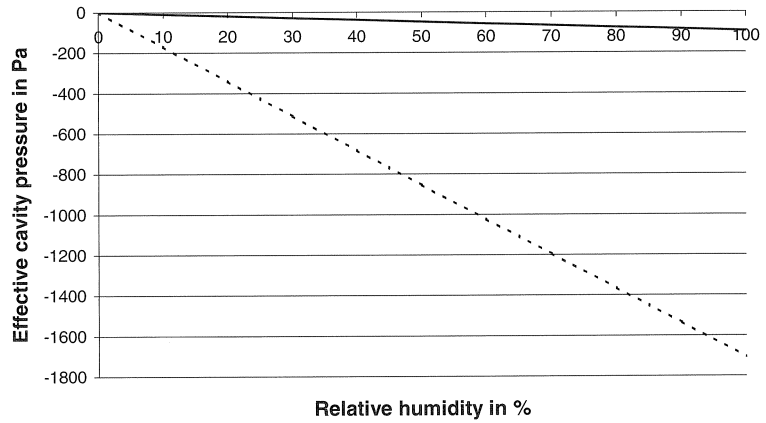

a [m]	b [m]	t_b [m]	t_o [m]	d_{cav} [m]	T_b [K]	p_b [Pa]
1.0	1.0	0.006 (solid line) ∞ (dotted line)	0.006 (solid line) ∞ (dotted line)	0.015	288	100,000
V_b [m ³]	α [°]	R.H. [%]	p_a [Pa]	T_a [K]	p_e [Pa]	V_e [m ³]
0.015	0.0	Var.	100,000	288	Var.	Var. (solid line) 0.015 (dotted line)

Figure 2: Effective cavity pressure in an insulating glass unit with panes with a limited flexural stiffness (solid line) and an infinite flexural stiffness (dotted line), as function of the relative humidity of the cavity air.

The largest effective cavity pressure will occur in case of atmospheric pressure with very stiff glass panes (see figure 3). The stiffer the both glass panes the more difficult the both glass panes will deform, thus the smaller the change in volume and the larger the pressure compensation.

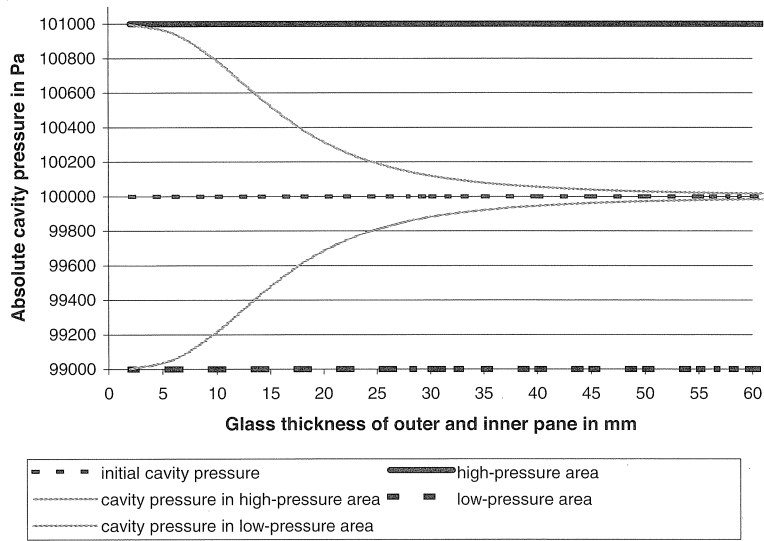

a [m]	b [m]	t_b [m]	t_o [m]	$d_{cav.}$ [m]	T_b [K]	p_b [Pa]
1.0	1.0	Var.	Var.	0.015	288	100,000
V_b [m ³]	α [°]	R.H. [%]	p_a [Pa]	T_a [K]	p_e [Pa]	V_e [m ³]
0.015	0.0	0.0	Var.	288	Var.	Var.

Figure 3: The interaction between atmospheric pressure and cavity pressure for several (identical) thicknesses of the outer and inner glass pane.

Finally, the largest effective cavity pressure will occur in case of change in ambient temperature with stiff glass panes (see figure 4). It is the same principle as mentioned before. The stiffer the glass panes the smaller the change in volume that occurs, thus the larger cavity pressure compensation.

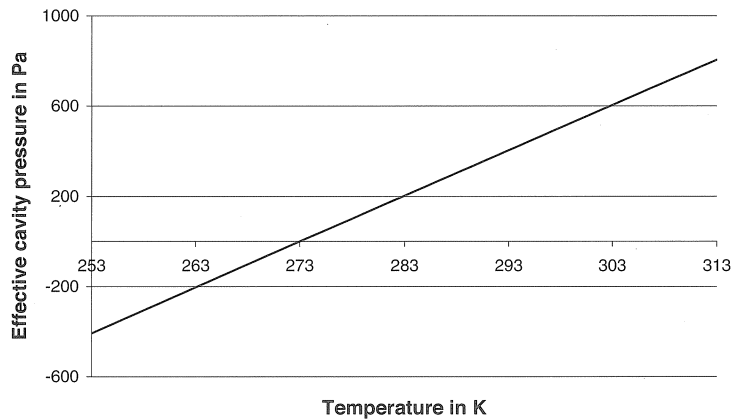

a [m]	b [m]	t_b [m]	t_o [m]	d_{cav} [m]	T_b [K]	p_b [Pa]
1.0	1.0	0.006	0.006	0.015	273	100,000
V_b [m ³]	α [°]	<i>R.H.</i> [%]	p_a [Pa]	T_a [K]	p_e [Pa]	V_e [m ³]
0.015	0.0	0.0	100,000	Var.	Var.	Var.

Figure 4: Effective cavity pressure ($p_{eff} = p_e - p_a$) in relation to ambient temperature for hinge supported insulated double glass units with 6 mm glass panes.

4.4.2 Mechanical loading

In addition to thermo-mechanical loads, a horizontal insulated double glass unit also need to resist uniformly distributed loads like its dead weight, wind and snow loads and a free concentrated load due to a person on the outer glass pane for maintenance or cleaning.

The uniformly distributed load on the outer glass pane results in deformation of this pane, a decrease of the cavity volume and an increase of the cavity pressure. This results in an upward load on the outer pane and a downward load on the inner pane. A part of the load is transferred by the cavity (acting as a spring) from the outer to the inner pane: load sharing. The difference in deformation of both panes results in a change of volume of the cavity and by that a change of pressure (Δp) in the cavity. The magnitude of change of cavity pressure depends on the stiffness of the panes. The stiffer the direct loaded outer pane, the smaller the change of cavity pressure. The stiffer the inner pane (indirect loaded), the larger the change of cavity pressure will be.

For a concentrated load, the principle of load sharing is the same. Because the load is concentrated on a small surface, the deformation of the pane is larger than in case of a uniformly distributed load with the same resultant. The change of cavity pressure (Δp) is partly reduced by the so called 'cushion effect': next to the location of the concentrated load the directly loaded pane deforms upwards

(see figure 5). The largest change of pressure occurs in case of a concentrated load in the centre of the pane. The influence of the load is perceptible over the whole area of the pane. In case of a load position near the supports, the change of cavity pressure is less due to a smaller deformation and the cushion effect. The thinner the direct loaded pane, the stronger the cushion effect (see figure 5 and 6). For very small insulated double glass units, the change of pressure is almost negligible.

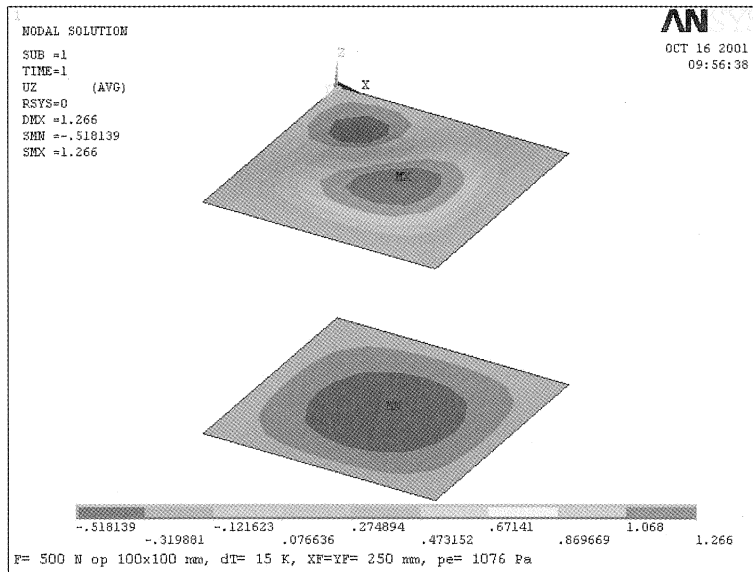

a [m]	b [m]	t_b [m]	t_o [m]	d_{cv} [m]	T_b [K]	p_b [Pa]	V_b [m ³]
1.0	1.0	0.006	0.012	0.015	288	100,000	0.015
α [°]	R.H. [%]	p_a [Pa]	T_a [K]	p_c [Pa]	V_c [m ³]	F [N]	$x_F ; y_F$ [m]
0.0	0.0	100,000	303	101,076	0.015613248	500 (on 0.1x0.1 m)	0.25 ; 0.25

Figure 5: Deformation of an outer and inner pane, modelled according to the linear plate theory, under a concentrated load on the outer pane at a distance of 0.25 meter from the edge and also loaded by $\Delta T = 15$ K and own weight.

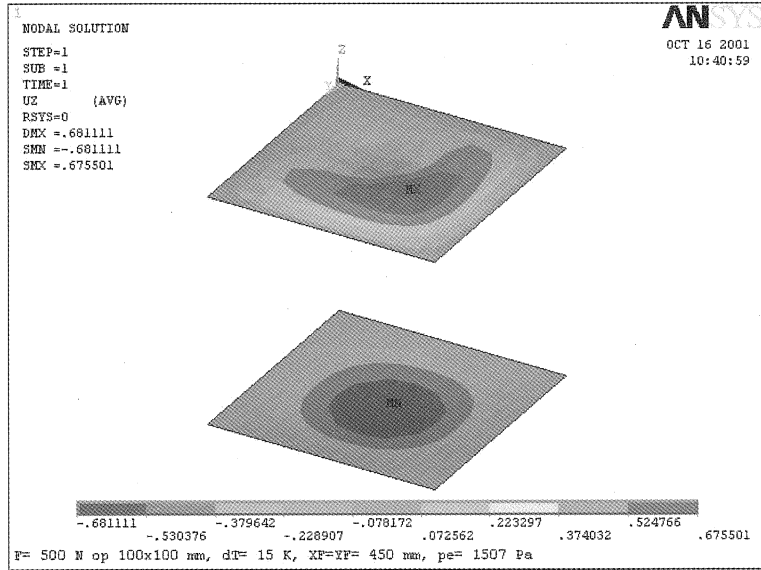

a [m]	b [m]	t_b [m]	t_o [m]	d_{av} [m]	T_b [K]	p_b [Pa]	V_b [m ³]
1.0	1.0	0.006	0.012	0.015	288	100,000	0.015
α [°]	R.H. [%]	p_a [Pa]	T_a [K]	p_e [Pa]	V_e [m ³]	F [N]	$x_F ; y_F$ [m]
0.0	0.0	100,000	303	101,507	0.015546952	500	0.45 ; 0.45 (on 0.1x0.1 m)

Figure 6: Deformation of an outer and inner pane, modelled according to the linear plate theory, under a concentrated load on the outer pane at a distance of 0.45 meter from the edge and also loaded by $\Delta T = 15$ K and own weight.

In the actual standards, an insulated double glass unit is modelled as two plates on each other without a shear connection. In case of deformation by bending, the plates slide over each other. The load sharing over both plates is determined based on the stiffness ratio. In case of uniformly distributed loads, this is a realistic approach, because both plates deform congruently. The present design rule in the Dutch standard is not valid anymore for the load case climate load and mechanical load, and the formulas (2) up to (9) should be used to determine the cavity pressure and consequently the loading of the panes.

5 Experimental research

5.1 Methodology

To verify the analytical models an experimental research was carried out. Eight different specimens of insulated double glass units were tested under uniformly distributed and concentrated loads (see table 4). On each specimen, 4 tests were carried out, namely one with a uniformly distributed load and three with a concentrated load on different locations. During the tests the value of the load, the pressure in the cavity and the deformation of both panes were measured. The ambient atmospheric pressure and temperature were kept constant during the tests.

It is very important to measure the thickness of glass pane 1 as well as of glass pane 2 with great accuracy, because their impact in the calculations. All glass panes are measured separately before manufacturing in the factory. The thickness is measured around the edge at eight different places (see figure 7).

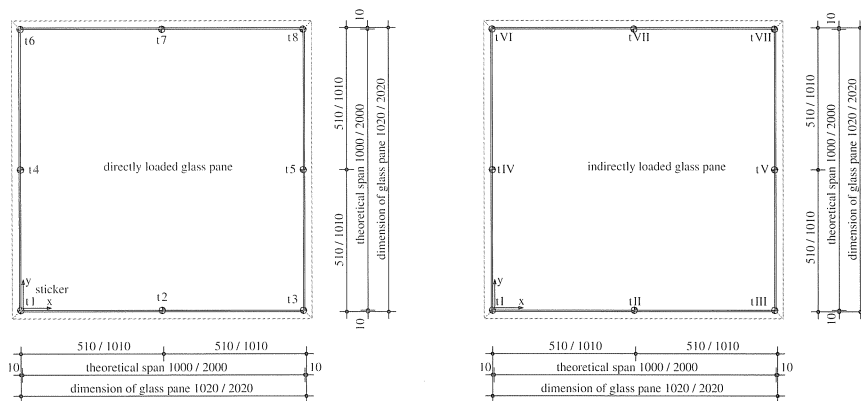

Figure 7: Measuring of the thickness of both glass panes before manufacturing to an insulated double glass unit.

Left: Glass pane 1 indicated with arabic numbers and marked.

Right: Glass pane 2 indicated with roman numbers.

5.2 Test set up

5.2.1 Uniformly distributed load

One glass pane of the insulated double glass unit is loaded with a uniformly distributed load. Normally, an air cushion is used to simulate a uniformly distributed load. Because of the gauges at the upper glass pane (pane 1), an air box was chosen (see figure 10). The air box is connected with a manometer for measuring the air pressure in the air box. For measuring the cavity pressure, another manometer was used. The deformation of the panes under a uniformly distributed load was measured at three locations (see figure 8); the deformation under a concentrated load was measured at the points of intersection of 9×9 grid lines (see figure 11). All measuring instruments, namely two manometers and six displacement gauges, were connected with a computer, which registered the data at a time interval of two seconds.

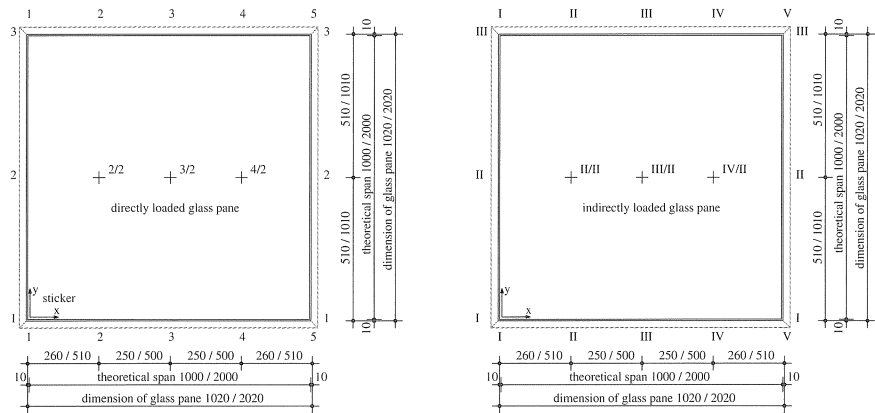

Figure 8: The positions with displacement gauges for uniformly distributed load.

Left: Glass pane 1.

Right: Glass pane 2.

The specimens were tested in horizontal position. Both glass panes will deform by gravitation. The initial position of the panes was measured therefore in vertical position (see figure 9 and 12). In vertical position, both glass panes are parallel to each other. The initial volume is defined as the cavity height multiplied by the internal area for the unit in vertical position.

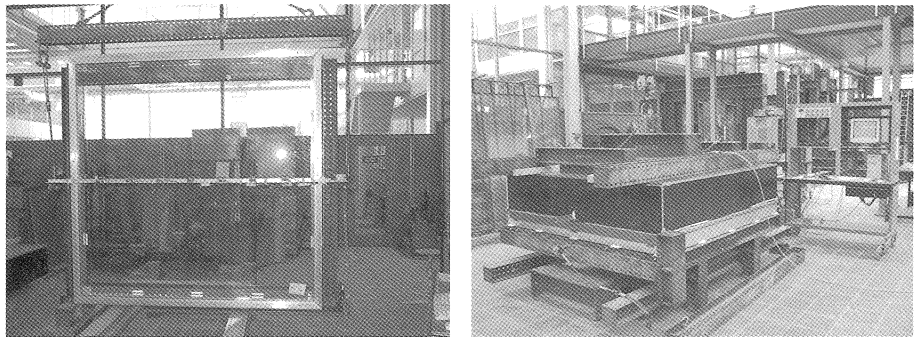

Figure 9: Left: Vertical position of the insulated double glass unit.

Right: Horizontal test position with air box in progress.

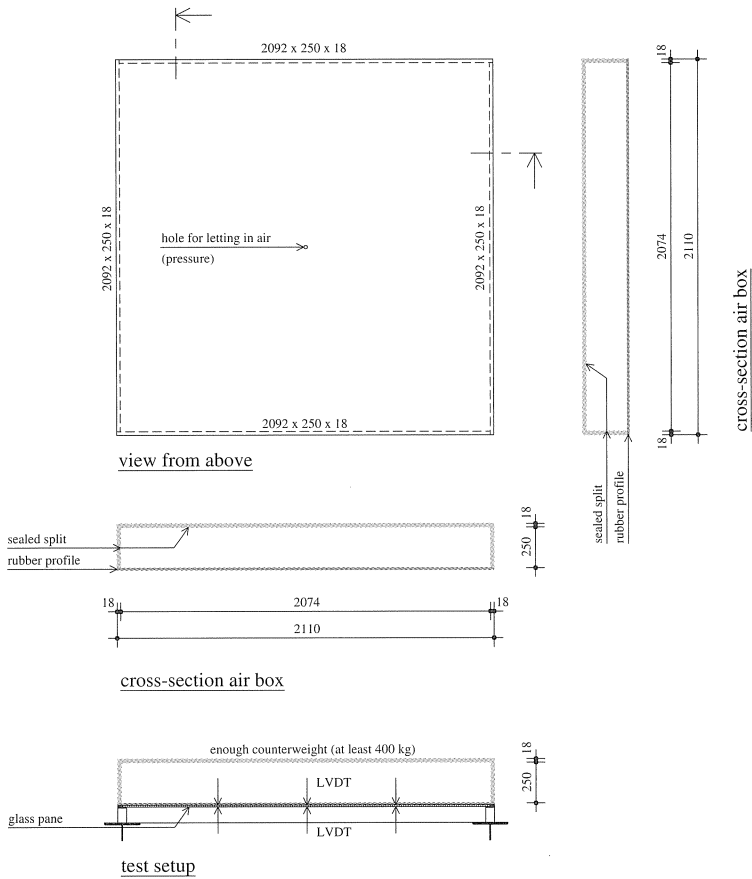

Figure 10: Test position with air box for the uniformly distributed load.

5.2.2 Concentrated load

The principle for measuring an insulated double glass unit with a concentrated load is the same as mentioned in section 4.2.1. The main difference is the directly loaded glass pane. The air box is replaced by an increasing weight with a loading surface of 100 mm x 100 mm. The deformation was measured at 49 points (rectangular grid) for each load step (see figure 11 and 12). The lattice with the 7 gauges was moved 7 times. This was done to register the cushion effect.

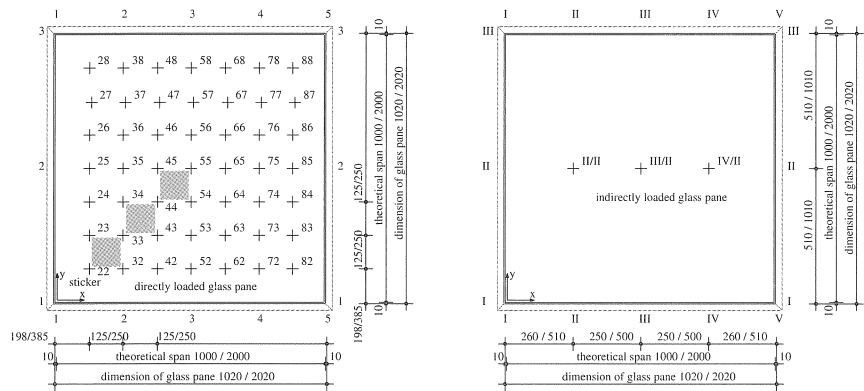

Figure 11: The positions with displacement gauges for concentrated load.

Left: Glass pane 1.

Load position at coordinate 198;198 and 385;385 are the following test numbers: 9, 12, 15, 18, 21, 24, 27 and 30.

Load position at coordinate 323;323 and 635;635 are the following test numbers: 10, 13, 16, 19, 22, 25, 28 and 31.

Load position at coordinate 448;448 and 885;885 are the following test numbers: 11, 14, 17, 20, 23, 26, 29 and 32.

Right: Glass pane 2.

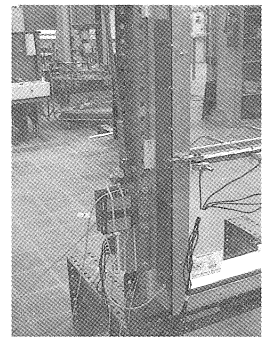
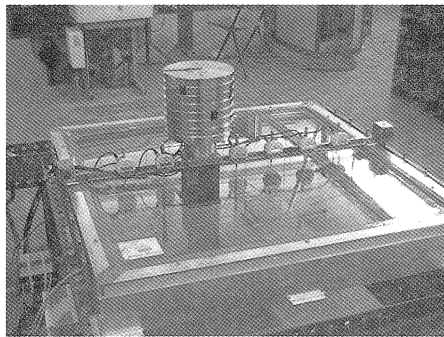

Figure 12: Left: Specimen loaded by a concentrated load.

Right: Vertical position of the insulated double glass. At both sides of the double glass unit three displacement gauges. Two manometers for measuring the pressure in the cavity (below) and in the air box (above).

5.3 Results

5.3.1 Uniformly distributed load

The deformations measured during the tests were smaller than the calculated deformations. At large deformations ($w \gg \frac{1}{2}t$), the membrane effect occurred and reduced the deformations tremendously. For small glass units, there were smaller deformations than calculated, due to the so-called ‘edge effect’. In the analytical models, both panes were connected to each other at the edges by hinges. In reality, the elastic sealant at the edges introduces a bending moment. This edge moment reduced the deformation of both panes, but introduced also extra stresses at the glass edges.

For large glass units, the membrane effect was dominant. The edge effect had no influence anymore on the entire deformation behaviour of both glass panes. However, the elastic sealant was so stiff and strong that the sealant introduced high edge moments and this resulted in additional stresses at the edge of both glass panes. Specially, in case of non-linear plate behaviour the maximum tension stress occurs at the corner of the plate.

The membrane and edge effect had influence on the deformation of both panes. This resulted in other changes of volume and pressure of the cavity. Table 4 gives an overview of the differences between the analytical and experimentally found cavity pressure.

Table 4: Overview of the differences between analytical and experimentally found cavity pressure.

Size	Test number	Geometry in mm	Analytical cavity pressure* in Pa	Experimental cavity pressure* in Pa	P _{c:ana.} versus P _{c:exp.}	Edge effect at cavity pressure		Membrane effect at cavity pressure	
						Top pane	Bottom pane	Top pane	Bottom pane
1000 mm x	1	4-15-4	443.48	452.50	≈	Yes	Yes	Yes	Yes
	2	4-15-8	814.53	746.29	>	Yes	Yes	No	No
1000 mm	3	8-15-4	30.08	50.57	<	Yes	Yes	No	No
	4	8-15-8	389.80	400.23	≈	Yes	Yes	No	No
2000 mm x	5	6-15-6	458.94	469.76	≈	No	No	Yes	Yes
	6	6-15-8	700.64	577.48	>	No	No	Yes	Yes
2000 mm	7	8-15-6	216.53	286.44	<	No	No	Yes	Yes
	8	8-15-8	463.65	473.61	≈	No	No	Yes	Yes

*The cavity pressure under the largest uniform distributed load (about 1000 Pa) on the insulated double glass unit.

- > the analytical cavity pressure is larger than the experimentally found cavity pressure.
- < the analytical cavity pressure is smaller than the experimentally found cavity pressure.

In case of equal thickness of the both glass panes, there was almost no difference in cavity pressure according to the analytical model and the test results. The cavity pressure as measured was lower than calculated in case of a thin outer glass pane. The membrane effect reduced the deformation of the outer pane, and thereby reduced the increase of the cavity pressure. The cavity pressure as measured was larger than calculated in case of a thin inner pane. The membrane effect reduced the deformation of the inner pane and thereby increasing the cavity pressure.

5.3.2 Concentrated load

The deformations under a concentrated load were also influenced by the membrane and edge effect. Table 5 gives an overview of the differences between the analytical and experimentally found cavity pressure. The cushion effect was seen visually (figure 13).

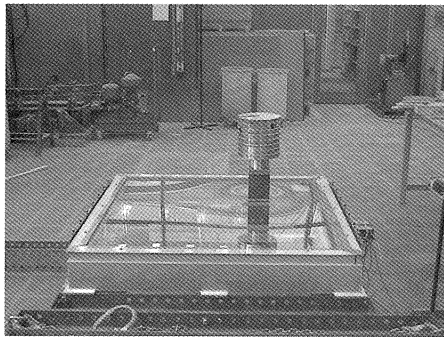

Figure 13: The cushion effect for an insulated double glass unit of 1000 mm x 1000 mm, loaded by a concentrated load at coordinate 323;323 mm.

Test number 9 showed almost the same cavity pressure according to analytical model and the test results. When the concentrated load moved to the centre of the pane (see test 10 and 11) the measured cavity pressure got constantly lower, because the membrane and edge effect reduced the deformation of the directly loaded pane. The test numbers 18 to 20 had almost the same cavity pressure, because of the linear behaviour of both glass panes. The deformations of both glass panes were influenced by the edge effect. The test numbers 12 to 14 showed constantly a lower cavity pressure, because of the membrane effect of the directly loaded glass pane. The test numbers 15 to 17 showed the inverse of test numbers 12 to 14, because of the membrane effect of the indirectly loaded glass pane.

Test numbers 21 to 26 and test numbers 30 to 32 showed a cavity pressure lower than according to the analytical model, because of membrane effect of the directly loaded glass pane. Test numbers 27 to 29 gave a higher cavity pressure, because of the membrane effect of the indirectly loaded glass pane.

Table 5: Overview of the differences between analytical and experimentally found cavity pressure.

Size	Test number	Geometry in mm	Analytical cavity pressure* in Pa	Experimental cavity pressure* in Pa	p _{c,ana.} versus p _{c,exp.}	Edge effect at cavity pressure		Membrane effect at cavity pressure	
						Top pane	Bottom pane	Top pane	Bottom pane
1000 mm x 1000 mm	9	4-15-4	212.33	212.45	≈ → >	Yes	Yes	Yes	Yes
	10	4-15-4	431.53	389.20	>	Yes	Yes	Yes	Yes
	11	4-15-4	569.91	492.69	>	Yes	Yes	Yes	Yes
	12	4-15-8	437.98	386.84	>	Yes	Yes	Yes	No
	13	4-15-8	825.66	728.32	>	Yes	Yes	Yes	No
	14	4-15-8	1070.43	964.81	>	Yes	Yes	Yes	No
	15	8-15-4	-18.40	16.86	<	Yes	Yes	No	Yes
	16	8-15-4	27.24	79.70	<	Yes	Yes	No	Yes
	17	8-15-4	56.05	113.41	<	Yes	Yes	No	Yes
	18	8-15-8	189.83	199.93	≈ → >	Yes	Yes	No	No
19	8-15-8	386.21	397.87	≈ → >	Yes	Yes	No	No	
20	8-15-8	510.23	535.71	≈ → >	Yes	Yes	No	No	
2000 mm x 2000 mm	21	6-15-6	52.11	53.42	≈ → >	No	No	Yes	Yes
	22	6-15-6	108.27	96.43	>	No	No	Yes	Yes
	23	6-15-6	144.97	124.20	>	No	No	Yes	Yes
	24	6-15-8	119.79	87.14	>	No	No	Yes	Yes
	25	6-15-8	199.49	141.92	>	No	No	Yes	Yes
	26	6-15-8	251.57	173.53	>	No	No	Yes	Yes
	27	8-15-6	-16.66	9.54	<	No	No	Yes	Yes
	28	8-15-6	15.44	41.15	<	No	No	Yes	Yes
	29	8-15-6	36.42	56.52	<	No	No	Yes	Yes
	30	8-15-8	51.17	50.81	≈ → >	No	No	Yes	Yes
	31	8-15-8	106.81	99.28	≈ → >	No	No	Yes	Yes
	32	8-15-8	143.17	134.11	≈ → >	No	No	Yes	Yes

* The cavity pressure under the largest concentrated load (500,80 N).

≈ → > the analytical cavity pressure matches almost the experimentally found cavity pressure, but the difference will be larger at increasing concentrated load.

> the analytical cavity pressure is larger than the experimentally found cavity pressure.

< the analytical cavity pressure is smaller than the experimentally found cavity pressure.

6 Conclusions

The aim was to get more insight in the behaviour of especially non-uniformly distributed load and climate loads on insulated double glass units. The analytical models are based on linear mechanics. All influences, mechanical as well as thermo-mechanical, which act on an insulated double glass unit, can be modelled. This analytical model is not valid in case of two phenomena, namely the edge effect and the membrane effect. However, the model gives a good indication of the magnitude of the pressure of cavity in the real world. The edge effect and the membrane effect make the appropriated glass pane stiffer. The stronger the membrane effect and edge effect of the directly loaded glass pane the lower the cavity pressure (see table 4 and 5) will be than calculated in the analytical model. The stronger the membrane effect and edge effect of the indirectly loaded glass pane the higher the cavity pressure (see also table 4 and 5) will be compared to the calculate value in the analytical model.

In case of equal glass thicknesses under uniformly distributed load, the experimentally found cavity pressure is almost the same as the calculated cavity pressure. If the indirectly loaded glass pane is stiffer than the directly loaded glass pane, the cavity pressure is smaller than calculated in the analytical model. The indirectly loaded glass pane is less loaded than calculated. The directly loaded glass pane will be more loaded than calculated. Finally, the directly loaded glass pane acts stiffer than the indirectly loaded glass pane, the cavity pressure is larger than calculated in the analytical model. The directly loaded glass pane is less loaded than calculated. The indirectly loaded glass pane will be more loaded than calculated.

To correct the analytical model the edges have to be completed with a moment, which is related to rubbery behaviour of the sealant, and rotation. This behaviour is a physical non-linear behaviour. The second correction is the effect of geometric non-linear behaviour. This plate behaviour in combination with the sealant at the edge is so complex that the help of the finite element method is necessary.

Four diagrams are given in figure 14. The cavity pressure depends strongly on the load type and the dimension of the insulating double glass units. The cavity pressure increases under a uniformly distributed load with increasing length and reaches asymptotically a certain level. The uniformly distributed load keeps its influence for the whole directly loaded glass pane. This is the main difference with the concentrated load and the edge moment. Their influence decreases with increasing length. This results in decreasing of the cavity pressure. The cavity pressure also decreases under temperature load with increasing length (from very stiff plate behaviour to weak plate behaviour).

It is very important to pay attention to the stresses in the glass. The tensile strength of glass leads to failure of the whole glass pane. Membrane stresses in combination with edge effect introduce large maximum principal stresses in the corners of the glass pane. The present building practice calculates according to the linear mechanics. The maximum principal stress acts in the centre of the glass pane.

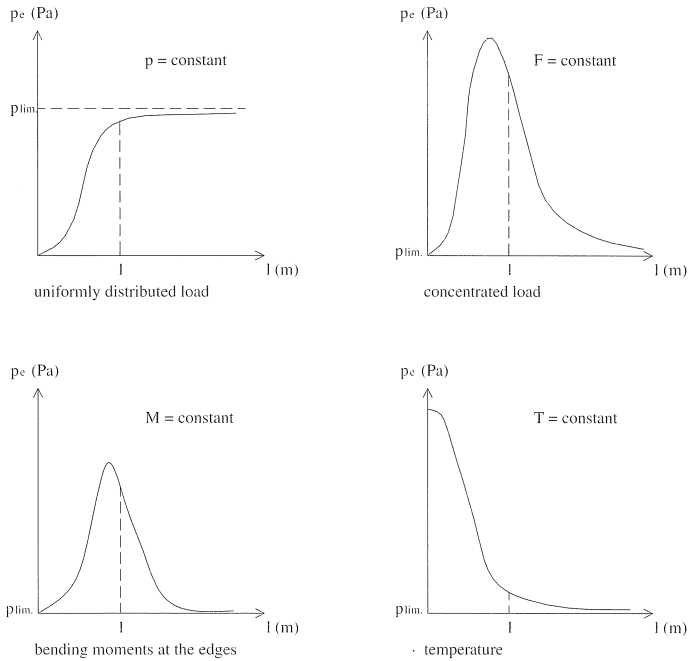

Figuur 14: Graphical overview of the cavity pressure with variable length of the glass pane under:

- constant uniformly distributed load (upper left side);
- constant concentrated load (upper right side);
- constant edge moment(s) (under left side);
- constant temperature (under right side).

7 Recommendation

As already stated the analytical model is the basis for further research. The current building practice calculates with simple formulae based on linear mechanics. The building practice needs simple design rules and not complex mathematical and physical formulae. Maybe the analytical model can be used for deriving design rules. Correcting the linear mechanics approach, factors have to be introduced to determine the pressure of cavity and the maximum principle stress finally.

The sealant around the edges of the insulated double glass unit is a very important parameter for the stress distribution in both glass panes. A research project has started to determine the mechanical properties of silicone and polysulphide sealant for implementation in the analytical model.

8 References

- [1] Huveners, E.M.P., Het gedrag van de spouw in geïsoleerde beglazing, Het bepalen van de spouwdruk uit mechanische en thermodynamische belastingen, graduate report of TU/e.
- [2] Sedlacek e.a., Prof. Dr. Ing. G.: *Glas im Konstruktiven Ingenieurbau (Bauingenieur-Praxis)*, 1st edition, publishing of Ernst & Sohn (A Wiley Company), Berlin 1999, ISBN 3-433-01745-X.
- [3] NEN 6702, *Belastingen en vervormingen*, publishing of the Dutch Code Institute.
- [4] NEN 2608, *Vlakglas voor gebouwen – Weerstand tegen windbelasting – Eisen en bepalingmethode*, publishing of the Dutch Code Institute.
- [5] NEN 2608-2, *Vlakglas voor gebouwen – Niet-verticaal geplaatst glas – Weerstand tegen windbelasting, sneeuw en eigengewicht – Eisen en bepalingmethode*, publishing of the Dutch Code Institute.
- [6] Young, Hugh D. en Freedman, Roger A., *University Physics with modern physics*, 10th edition, publishing of Addison Wesley Longman Inc., 2000, ISBN 0-201-60336-5.
- [7] Timoshenko, Prof. S: *Theory of Plates and Shells*, 2nd edition, publishing of McGraw-Hill Book Company, 1959.
- [8] Jawad, Maan H.: *Theory and Design of Plate and Shell Structures*, publishing of Chapman & Hall, 1994, ISBN 0-412-98181-5.
- [9] Aalami, B en Williams, D.G., *Thin Plate Design for Transverse Loading*, publishing of Crosby Lockwood Staples, London 1975, ISBN 0 258 96991 1.