

# Service life prediction and repair of concrete structures with spatial variability

Li Ying,

Royal Haskoning, China, Delft University of Technology, Delft, The Netherlands

Ton Vrouwenvelder,

Delft University of Technology, Delft, The Netherlands

Due to various mechanical, physical and chemical processes, concrete structures are subject to deterioration such as rebar corrosion, cracking and spalling. As most parameters in those processes are random, probability-based reliability analysis is often applied. However, in most studies, spatial variability is not taken into account, although this phenomenon greatly affects the behaviour of concrete structures. The aim of this paper is to show the service life prediction procedure when spatial variability is included. Compared with the studies without consideration of spatial variability, the results can be considered as a better simulation of reality. Also the choice between different repair and maintenance strategies can be underpinned in a more realistic way. A hypothetical illustrative example is shown.

*Keywords: Service life, deterioration, concrete structure, spatial variability, repair criterion, maintenance, repair strategy*

## 1 Introduction

According to standard degradation models, the process of concrete deterioration includes an initiation period and a propagation period. Models for the processes in these two periods are available (Engelund and Sørensen, 1998; Duracrete, 1998; Duracrete 2000). As most parameters in those models are random, probability based analysis is often applied. However, the fact that many parameters also show a random spatial variability is usually not explicitly taken into account. These variations in behaviour may be linked to dependencies on temperature, water binder ratio, micro climate, humidity and workmanship (Chryssanthopoulos, 2002).

Spatial variability of physical properties includes systematic spatial variation (variation of the mean value and standard deviation) and random spatial variation. Consider by way of example a concrete bridge deck: the chloride content at the side-areas of the deck is normally higher than in the centre part of the deck due to the spray of chloride by passing vehicles. As a result the mean of the chloride content is higher at the two side areas than in the centre, this effect is called "systematic spatial variation". At the same time the chloride content varies from point to point around its corresponding mean value, independent of the area under consideration. This property is called "random spatial variation".

The systematic spatial variation is relatively easy to handle since we know (by definition) its variation laws. For example, the previously mentioned concrete bridge deck can be subdivided into smaller regions or elements (e.g. two regions at the two side areas of the deck and one region in the middle part of the deck) where it is assumed that no systematic spatial variation takes place with each region. For random spatial variation, it is more complex and difficult; a more advanced modelling of the random variables as well as a more advanced calculation procedure are necessary. It will be introduced later in this paper.

Many current studies neglect the random spatial variation within a structure or an element and take the whole structure or element as fully correlated, that is homogeneous; the result at one point holds for the entire element. Such a model would only suggest a total repair or replacement of the structure or the element and local repair seems to be ruled out as a reasonable option. It maybe clear that such a model is not suited in all cases (Duracrete, 1999a). For example, the appearance of rust stains, cracking and spalling of concrete structures are not the same across the whole concrete surface, and the level of exposure to aggressive agents such as chlorides is also spatially variable. One should be aware that all such spatial variations might be important and could significantly influence the structural and serviceability performance of structural systems. The influence of the spatial variation of physical quantities on the reliability analysis is discussed in (Li, et al, 2003). Stewart (2003) has found that the inclusion of spatial variability of pitting corrosion can lead to significant decreases in structural reliability, at least for flexural reinforced concrete structural members. Therefore, if the spatial variation is perceived to be important, it should be modelled in such a way that the correct decisions can be derived from the model. This paper is concerned with the service life analysis of concrete structures by using

an advanced spatial variability approach, which implements the random spatial variation of property differences across the structure. A hypothetical concrete bridge element deteriorating due to chloride-initiated corrosion is illustrated to show the service life prediction and its optimal repair strategy.

## 2 Service life analysis of concrete structures with spatial variation

In probabilistic analysis, three steps can be distinguished:

1. Definition of failure modes (limit states) and corresponding models.
2. Quantification of the statistics of the random variables
3. Calculation of the desired results as for instance failure probabilities.

In this paper a durability analysis for concrete structures is carried out. Special attention is given to the spatial variability of the random quantities. This has consequences for the models in step 2 and, even more, for the analysis in step 3. Step 1 remains more or less unaltered, but will be discussed for the sake of completeness.

### 2.1 Service life models

The service life of concrete structures is commonly modelled as a two stage process, defined respectively as the “initiation” and the “propagation” stage (see Figure 1.) Many studies have already been performed based on these processes over the last decades. Physical modelling is possible by reasonable approximation, although some aspects are still under debate. The limit state functions (critical failure modes) will be developed based on these physical models.

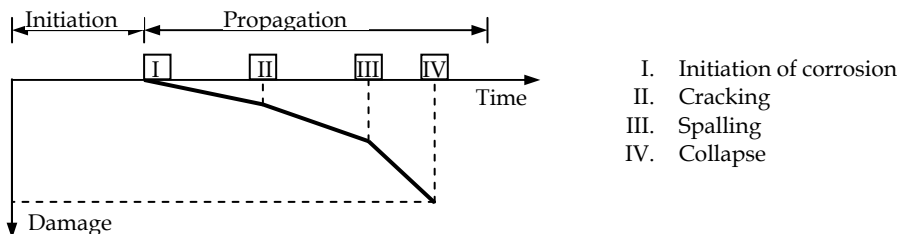

Figure 1: Main events related to the service life of concrete structures

The initiation period is a period during which chloride ingress occurs into the concrete cover until, eventually, depassivation takes place and rebar corrosion starts. In the model this event is associated with a critical chloride concentration at the depth of the rebars. Once corrosion of a rebar in concrete has been initiated, phenomena may occur such as reduced rebar cross-section, deterioration of concrete cover, cracking and spalling of concrete, loss of steel-to concrete bond, etc. If corrosion proceeds at a sufficiently high rate, all of these phenomena may negatively affect performance and eventually structural capacity (Duracrete, 2000). Actually, corrosion takes place during the whole propagation period. Initiation of rebar corrosion itself does not necessarily represent an undesirable state, but without initiation the probability of these negative phenomena is absent. This is why in many service life approaches, initiation is taken as an indicator of the need to carry out maintenance; usually preventive maintenance is sufficient to secure all required levels of performance. Models to predict corrosion initiation are simpler and more elaborated than models to predict cross sectional loss of rebar, cracking or spalling.

## 2.2 *Statistical quantification of the variables*

The specification of a random quantity in the service life model for concrete structures needs to include:

1. Distribution type
2. Parameters like mean value and standard deviation
3. Its fluctuation pattern in time
4. Its fluctuation pattern in space

In most studies only the first two or three items are dealt with. In this paper, we will also deal with item 4. If a physical quantity fluctuates randomly in space, it is called a random field. The fluctuation includes the systematic (deterministically known) spatial variation and the random spatial variation. Systematic spatial variability may be taken into account by e.g. different values for chloride concentrations. In order to describe the spatial random field it is not sufficient to have only the distribution at an arbitrary point. The full description of a field requires additional modelling with respect to its correlation structure in space. A common type of field is the Gaussian field. Here the density function is Gaussian for all points in space. In order to describe such a process in detail we need to have:

1. The mean as a function of spatial co-ordinates
2. The standard deviation as a function of spatial co-ordinates
3. The correlation for each pair of points in space.

If the mean and the standard deviation do not depend on the spatial coordinates and the correlation is only a function of the distance  $\Delta x$  between two points, the field is called homogeneous. It is assumed here that the considered fields are homogeneous Gaussian fields. In reality, of course, random fields are seldom homogeneous. Many properties may differ systematically from point to point. For many applications, however, the homogeneous Gaussian field may be a helpful tool in the statistical description of spatial random properties. Note that it is also possible to superimpose a homogeneous field on a deterministic field that describes the systematic variations in space.

To describe a homogeneous Gaussian field, we need a value for the mean, a value for the standard deviation and a correlation function depending only on the distance  $\Delta x$ . The correlation  $\rho$  between different pair of points at distance  $\Delta x$  can be described by the following generally known expression:

$$\rho(\Delta x) = \rho_0 + (1 - \rho_0) \exp\left(-\left(\frac{\Delta x}{d}\right)^2\right) \quad (1)$$

where  $\rho_0$  represents the common source of correlation and  $d$  the scale of fluctuation [m]. By way of example, Figures 2 and 3 schematically show the fluctuation of the concrete cover of a beam and its correlation in space by distance when  $\rho_0 = 0.5$  and  $d = 2.0$  m.

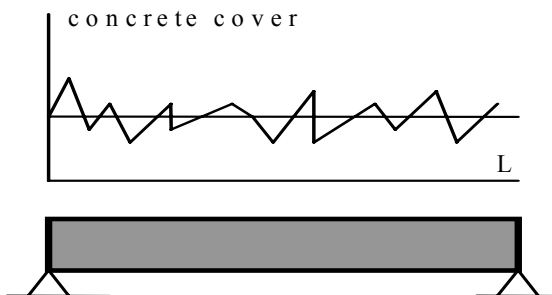

Figure 2: Realisation of spatial fluctuation of concrete cover along a beam, corresponding to the correlation function of Figure 3, where  $L$  is in the order of 20 m

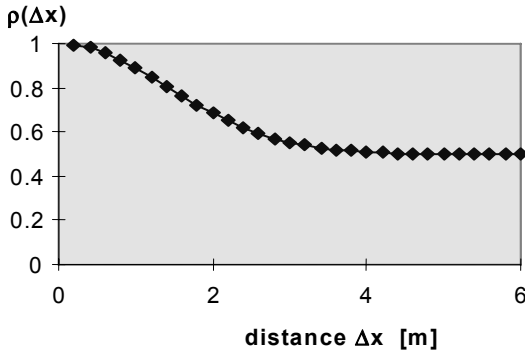

Figure 3: Correlation function according to Eq. (1) when  $\rho_0 = 0.5$  and  $d = 2.0$  m

### 2.3 Reliability calculations

A structure can be divided into regions based on different criteria, for example based on vulnerability to damage, environmental condition, loading or construction situation, etc. Each region is considered as an independent random spatial field, systematic (known) spatial variability within the region is neglected. For reasons of simplicity, this paper focuses on one rectangular shaped region only. To enable a numerical calculation procedure the region is divided into smaller elements. This is shown in Figure 4 for the one dimensional and in Figure 5 for the two dimensional case. It is assumed that there is no spatial variation within one element, so the distance between two element centres should be in the order of half the scale of fluctuation  $d$ . Experience shows that this provides sufficient accuracy.

The Monte Carlo Method can be used to perform the reliability analysis with respect to the occurrence of each possible failure mode. In this paper it is carried out in the space of independent standard normal variables. Therefore, a transformation must be carried out for the correlated random variables due to the spatial variability (Thoft-Christensen, 1986).

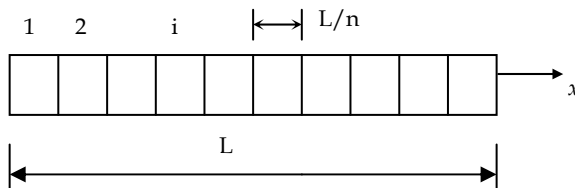

Figure 4: Schematisation of 1-dimension model ( $L/n < 0.5d$ )

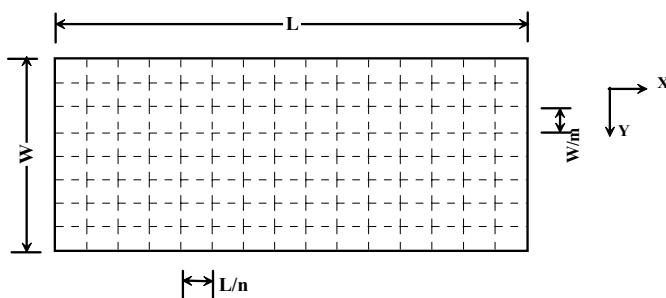

Figure 5: Schematisation of 2-dimension model

The Monte Carlo analysis results in a full probabilistic description of the state of the structure as a function of time. The effect of various inspection and maintenance strategies can easily be incorporated. An illustrative example is shown in the next section.

### 3 Illustrative example

#### 3.1 Introduction

The bridge-element of the motorway over the Eastern Scheldt Storm Surge Barrier in the southwestern part of the Netherlands, built in 1980, is chosen to illustrate the models introduced in the previous sections for the service life prediction with spatial variation of concrete degradation. This structure was investigated as part of a study of durability of concrete structures along the Dutch coast (Polder & Rooij, 2005). The side view and cross section of the bridge can be seen from Figures 6 and 7.

We focus here on the part indicated as section G. The dominant deterioration mechanism for the concrete bridge-element is corrosion of rebar due to chlorides from the sea. The predicted service life is compared with its design service life of 50 years.

#### 3.2 Models for the service life prediction

It is assumed that the service life of the bridge element includes the initiation period and the propagation period until cracking and spalling occur. The end of service life is defined in two ways: (1) when 5% of the area shows concrete spalling; and (2) when 30% of the area shows concrete cracking.

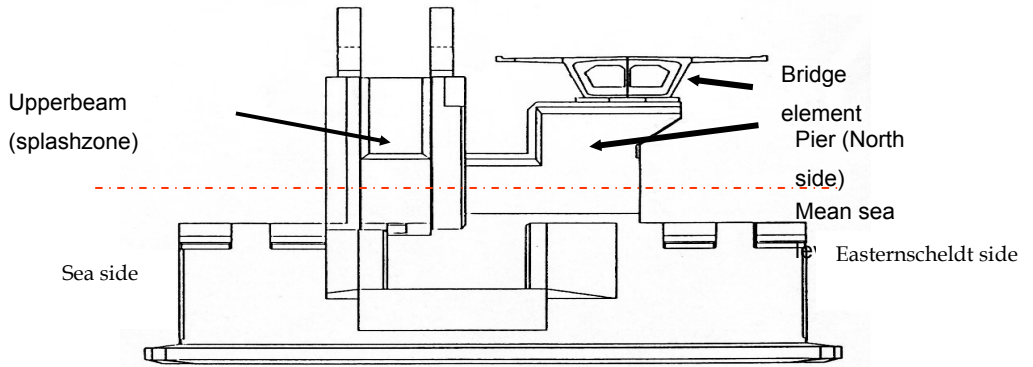

Figure 6: Cross section of the storm surge barrier

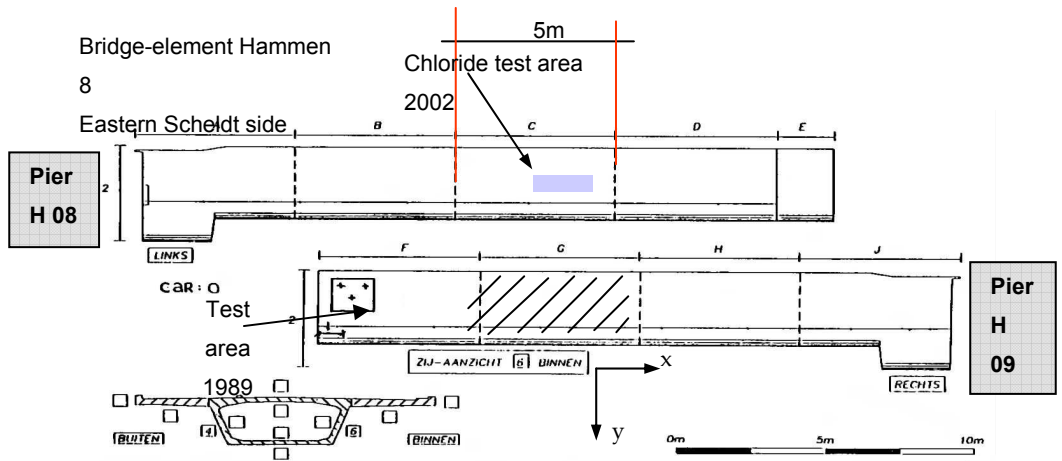

Figure 7: Side view of the bridge element

The limit state function for the initiation of rebar corrosion and the chloride content in the cover depth at year  $t$  can be modelled by the following equations (Duracrete, 1998):

$$g(t) = c_{Cl;cr} - c_{Cl}(t) \quad (2)$$

$$c_{Cl}(t) = c_{Cl;s} \cdot \operatorname{erfc} \frac{c}{\sqrt{4 \cdot D_{Cl} \cdot t}} \quad (3)$$



where  $c_{Cl,s}$  and  $c_{Cl}(t)$  are the chloride concentration at the surface and at depth  $c$  respectively;  $c_{Cl,cr}$  is the critical chloride concentration and  $D_{Cl}$  is the chloride diffusion coefficient; finally  $c$  is the cover depth from the surface to the rebar and  $t$  the time. The propagation period is controlled by the width of corrosion induced cracks in the concrete cover, therefore the limit state function can be written as:

$$g(t_p) = w_{cr,i} - w(t_p) \quad (4)$$

The actual crack width at  $t_p$  (time since initiation) can be estimated by (Duracrete, 1998 and 1999b):

$$w(t_p) = 0.05 + \beta \cdot [V_{corr,a} \cdot w_t \cdot \alpha \cdot t_p - (a_1 + a_2 \cdot c / \phi + a_3 \cdot f_{t,spl})] \quad (5)$$

and  $w_{cr,i}$  is the critical value of the crack width ( $i = 1$  for cracking,  $i = 2$  for spalling). In these equations  $V_{corr,a}$  is the corrosion rate,  $w_t$  the fraction of time that corrosion is active (wet periods),  $a$  the pitting factor,  $\phi$  the bar diameter and  $f_{t,spl}$  the concrete (splitting) tensile strength. The parameters  $\beta$  and  $(a_1, a_2, a_3)$  are fitting parameters.

### 3.3 Statistical quantification

The input for the deterministic parameters and stochastic variables for the models of the initiation period and the propagation period are shown in Tables 1 and 2. Where relevant a reference is given.

From the data of the chloride profile investigations (Rooij & Polder, 2002 and Polder & Rooij, 2005) it may be concluded that the following four variables are important and also show spatial variation:

1. The diffusion coefficient  $D_{Cl}$  (initiation phase)
2. The surface chloride concentration  $c_{Cl,s}$  (initiation phase)
3. Average corrosion rate  $V_{corr,a}$  (propagation phase)
4. Fraction of time that corrosion is active  $w_t$ , wetness period, (propagation phase)

The concrete quality for the bridge elements under consideration is very good (Rooij & Polder, 2002), the concrete cover and the basic concrete splitting strength have a very small standard deviation. Although normally these two variables probably show spatial

Table 1: Input data for initiation period (Rooij & Polder, 2002; Polder & Rooij, 2005)

Variable	Distribution	Mean	Standard Deviation
$c_{Cl_s}$	Normal	5.3% (by mass of cement)	1.47% (by mass of cement)
$c_{Cl_{cr}}$	Normal	0.5% (by mass of cement)	0.1% (by mass of cement)
$D_{Cl}$	Normal	8.83 E-6 m <sup>2</sup> /a	3.69 E-6 m <sup>2</sup> /a
$c$	Normal	41.1 mm	1.4 mm

Table 2: Input data for propagation period

Variable	Distribution	Mean	Standard Deviation.	Reference
$\beta$		8.6 (top)		Duracrete, 1999b
	Normal	10.4 (bottom)	2.85	
		9.5 (average)		
$V_{corr,a}$	Normal	0.003 mm/yr	0.004 mm/yr	Duracrete, 1999b
$w_t$	Normal	0.5	0.12	Duracrete, 1999b
$a$	Normal	9.28	4.04	Duracrete, 1999b
$a_1$	Normal	74.4 mm	5.7 mm	Duracrete, 1999b
$a_2$	Normal	7.3 mm	0.06 mm	Duracrete, 1999b
$a_3$	Normal	-17.4 mm/MPa	3.2 mm/MPa	Duracrete, 1999b
$c$	Normal	0.0411 m	0.0014 m	Rooij & Polder, 2002
$\varphi$	Deterministic	0.0010 m		Rooij & Polder, 2002
$t_{age}$	Deterministic	20 (age at the inspection year)		
$f_{t,spl}$	Normal	4.4 MPa	0.2 MPa	Rooij & Polder, 2002
$w_{cr,1}$	Normal	0.3 mm	0.06 mm	Duracrete, 1999b
$w_{cr,2}$	Normal	1.0 mm	0.20 mm	Duracrete, 1999b

variation, their spatial variation is neglected in this example. Based on a dataset of 6 measurements in a test area of about 2 x 0.5 m<sup>2</sup> on bridge element H8 (see figure 7), (Li, 2003) has shown that the fluctuation scale for the variables  $D_{Cl}$  and  $c_{Cl_s}$  is at least larger than 0.5 m. Unfortunately the data did not allow much more definite conclusions. In this example a fluctuation scale of 2 m is selected for these two variables. The same value is taken for the other two variables. The common source of correlation ( $\rho_0$ ) for all the elements is set to be zero.

### 3.4 Service life Calculation

Region G (see shading in Figure 7) has dimensions of 5 by 2 m. The region has been divided into  $n = 20$  equal elements along the  $x$  direction and  $m = 10$  equal elements in the  $y$  direction.

The relative area with initiated rebar corrosion, cracking and spalling in the region G, as a function of time during 80 years, is shown in the Figure 8. The lower and upper bound limits are presented in terms of 20% and 80% fractiles respectively. Figure 9 shows the mean results for the states of initiation of rebar corrosion, cracking and spalling.

One possible but arbitrary definition for the end of the life is that 5% of the surface suffers from spalling. A second one could be related to cracking e.g. 30% of the surface. The first criterion leads to an average end of life in about 35 years. At that point in time, about 55% of the surface has undergone initiation of rebar corrosion and 18% area shows concrete cracking. In the case of the 30% cracking criterion, we find a life of 40 years.

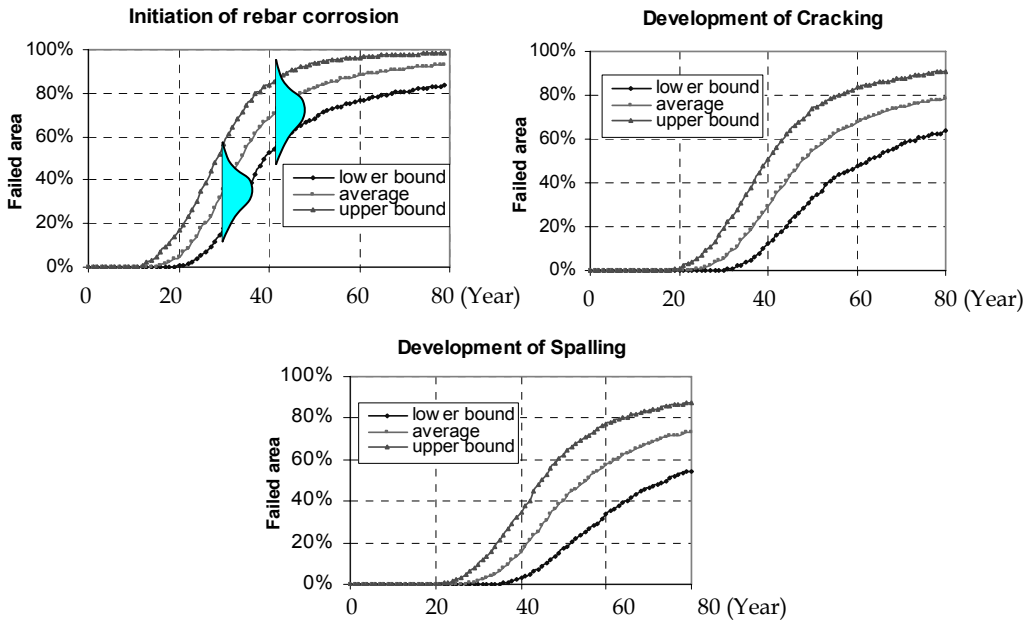

Figure 8: Development of initiation of rebar corrosion, cracking and spalling during 80 years

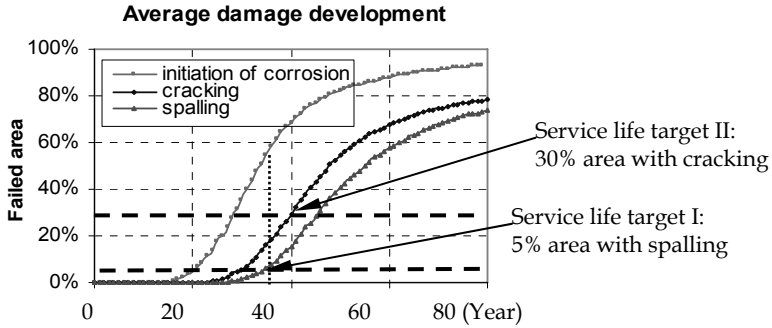

Figure 9: Average damage development of initiation, corrosion and spalling

### 3.5 Optimal maintenance strategy

The assessment of concrete structures is primarily based on visual inspections that are aimed at recording the signs of deterioration. The criterion for the onset of repair and maintenance in practice is based on a given part of the surface of the structure that shows signs of corrosion such as rust stains, cracks, spalling or delamination of concrete. The previous results under the given example conditions show that the average structure does not meet the design service life of 50 years. If we want (at least) to meet the design service life of 50 years, interventions are necessary. Three repair strategies are discussed in the next section to extend the service life of the structure based on the repair criterion of 5% visible area with spalling (Figure 10).

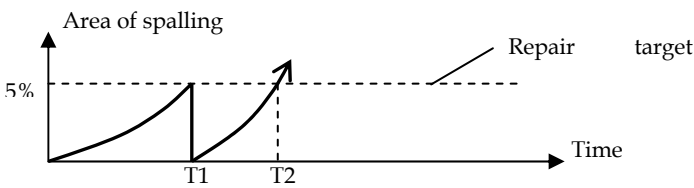

Figure 10: Criterion for repair strategy

The optimal maintenance strategy is defined as the one giving minimum expected maintenance cost  $E[C]$  (Frangopol, 1999; Gasser, 1999; Li 2004). Human safety is not relevant. In this paper the value of  $E[C]$  is calculated from:

$$E[C] = E[C_{insp}] + E[C_{rep}] \quad (6)$$

$$E[C_{insp}] = \sum_{k=1}^{m_i} \frac{C_{insp,k}}{(1+r)^{t_k}} \quad (7)$$

$$E[C_{rep}] = \sum_{j=1}^{n_r} \frac{C_{rep,j}}{(1+r)^{t_j}} \quad (8)$$

$$C_{rep;j} = C_0 + C_u \cdot \sum A_{rep;i} \quad (9)$$

Where  $C_{insp}$  is the cost of one inspection (50 €),  $m_i$  is the number of inspections,  $t_k$  is time of inspection (in years),  $r$  the interest rate (0.02/yr),  $C_{rep}$  the repair costs,  $n_r$  the number of repair cycles,  $t_j$  the time of repair (in years),  $C_0$  the initial cost for each of block of repairs (5000 €),  $C_u$  the unit repair cost (2000 €/m<sup>2</sup>) and  $\sum A_{rep;i}$  the total repaired area. The cases of renewal at the end of the life time are neglected. These costs will be roughly the same for all alternatives.

A repair strategy is defined as a set of predefined and related measures with the aim to enlarge the service life of the structure. Three different repair strategies are compared:

- a Strategy 1: Repair is carried out for the elements showing spalling (Figure 11).
- b Strategy 2: Repair is carried out for the elements showing spalling and the adjacent elements in the rebar direction (Figure 12), that is, horizontal.
- c Strategy 3: Repair is carried out for the area showing spalling and the surrounding area (Figure 13) (horizontal & vertical).

In all cases the 5% spalling criterion is adopted.

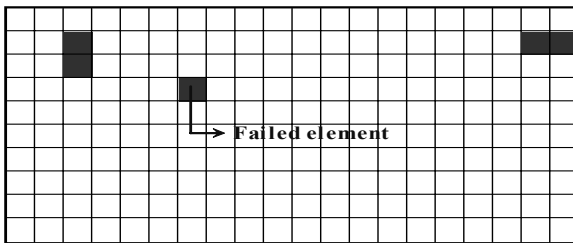

Figure 11: Strategy 1: Only failed (spalling) elements will be repaired

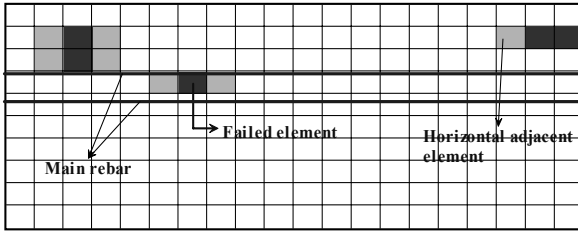

Figure 12: Strategy 2: Failed (spalling) elements and its horizontally adjacent elements will be repaired

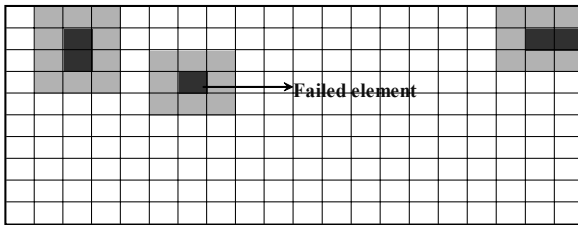

Figure 13: Strategy 3: Besides failed elements, all its surrounding elements will be repaired

It is assumed that repair is carried out only within the design service life of 50 years and repaired elements will recover to the state of new.

The effects of different strategies are shown in Figure 14. All three strategies can satisfy that within the period of 50 years the spalling of concrete never exceeds the 5% limit. As there is no repair after 50 years, all curves in Figure 14 show turn points around year 50. Expected yearly repair costs (including annual inspection costs) for different strategies are shown in Figure 14. All the costs are discounted to the value in year 0. It shows that the expected repair costs are relatively high from year 30 to 40. The total expected costs are compared in Figure 15, where strategy 3 has the minimum total cost.

#### 4 Conclusions

In this paper we have developed a realistic approach for evaluating the effect of spatial variation on deterioration and optimising the repair strategy for concrete structures. It is based on commonly used corrosion models and probabilistic-based reliability methods. Additionally it takes into account the spatial variability of concrete properties that has a

significant impact on design and maintenance decisions for structures. This approach reflects the actual situation more realistically and has the flexibility to implement spatial differences of the structural properties. It can provide useful information to back up the repair or maintenance strategy for concrete structures. Decision making for the optimal maintenance or repair strategy is based on the maintenance cost-based optimisation method. The approach has been demonstrated successfully in a practical case.

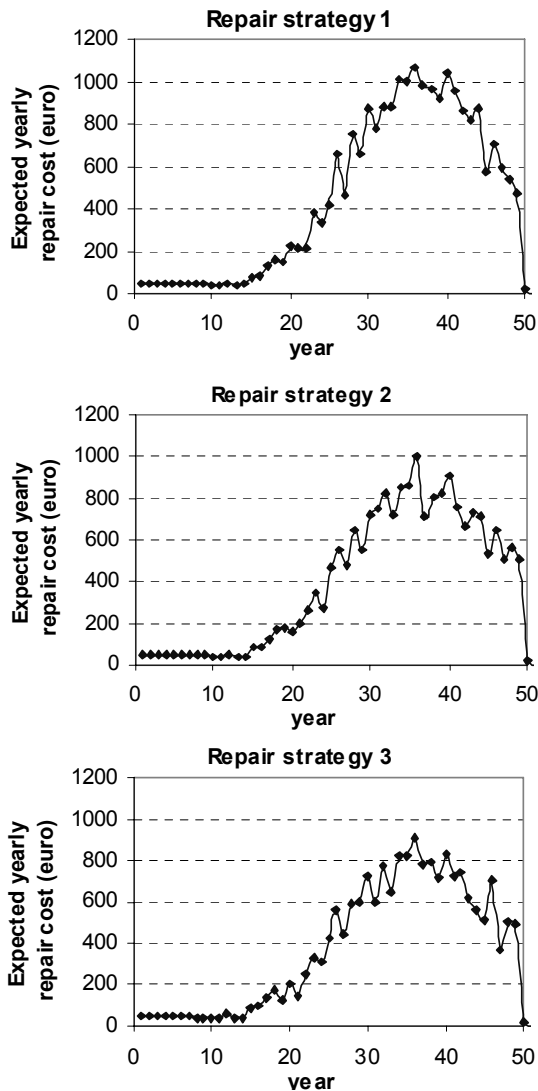

Figure 14: Expected yearly repair cost of strategy 1-3

From a practical perspective, the spatial variability of deterioration is a fact of life. From a theoretical perspective, prediction of the spatial variability presents a challenge. No standardization to a specific format has been used until now. For the scope of this research the availability of data about the actual variability are assumed to be present. Some practical issues in this area are still far from being resolved.

The deterioration models for concrete structures by the present studies in the world are still not very satisfying. There is a large amount of uncertainty that comes from inherent uncertain factors or from basic lack of knowledge.

The approach is worth of more research and development in the future.

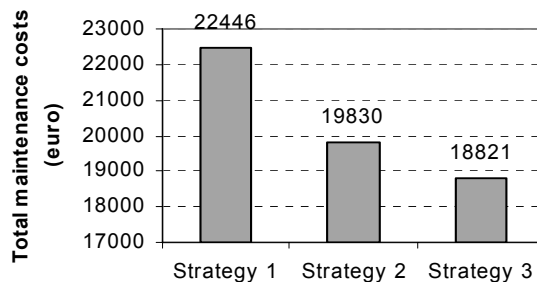

Figure 15: Expected total maintenance (repair + inspection) costs of different strategies

### **Acknowledgements**

The financial support of the Ministry of Transport, Public Works and Water Management (RWS), Netherlands School for Advanced Studies in Construction as well as the Netherlands Organization for Applied Scientific Research (TNO) is greatly appreciated. Appreciation also goes to Rob B. Polder and Mario de Rooij from TNO for sharing the data from the Eastern Scheldt study and their experience in practice.



## References:

- Chryssanthopoulos, M. K & Sterrit, G. (2002), "Integration of Deterioration Modelling and Reliability Assessment for Reinforced Concrete Structures", *ASRANet International Colloquium 2002*.
- Duracrete (1998), Modelling of Degradation, *The European Union - Brite Euram 111*, 1998.
- Duracrete (1999a), Probability Methods for Durability Design, *The European Union - Brite Euram III*, 1999.
- Duracrete (1999b), Statistical quantification of the variables in limit state functions, Document BE95-1347/R9, *CUR*, Gouda
- Duracrete (2000), Final Technical Report, Probabilistic performance based durability design of concrete structures, *The European Union-Brite EuRam III*, May 2000.
- Frangopol, D.M., and Estes, A.C. (1999), Optimum Lifetime Planning of Bridge Inspection and Repair Programs, *Structural Engineering International*, 3/99.
- Gasser, M. and Schuëller, G.I. (1999), "On optimising maintenance schedules by reliability based optimisation," *Case studies in optimal design and maintenance planning of civil infrastructures systems*, Frangopol, D.M. ed., 102-114.
- Li, Y., Vrouwenvelder, A. & Wijnants, G. H. (2003), "Spatial variability of concrete Degradation", *Proceedings for the Joint event JCSS & LCC Workshops in Swiss Federal Institute of Technology - EPFL, Lausanne, Switzerland, March 24-26, 2003*.
- Li, Y. (2004), *Effect of Spatial Variability on Maintenance and Repair Decisions for Concrete Structures*, PhD thesis, Delft University Press, 2004.
- Polder & Rooij (2005), Durability of marine concrete structures - field investigations and modelling, *HERON*, Vol. 50 (3), 133-143
- Rooij & Polder, (2002) , Investigation of the concrete structure of the Eastern Scheldt Barrier after 20 years of exposure to marine environment, *TNO-Report 2002-CI-R2118-3 final version*, Jan 2003; Appendices, Investigation of the influence of different exposure zones on concrete parts of the Eastern Scheldt Storm Surge Barrier, *TNO report 2002-CI-R2118-1A*, July 2002.
- Stewart, M.G. (2003), Effect of Spatial Variability Of Pitting Corrosion On Structural Fragility And Reliability Of RC Beams In Flexure, Research Report No. 232.02.2003, Discipline of Civil, *Surveying and Environmental Engineering*, The University of Newcastle, Australia.
- Thoft-Christensen P., Murotsu Y., "Application of Structural Systems Reliability Theory", Springer-Verlag, 1986.

