

# Concrete in compression and base plate in bending

Martin Steenhuis †

Eindhoven University of Technology, Faculty of Architecture, Building and Planning,  
the Netherlands

František Wald

Czech Technical University, Faculty of Civil Engineering, Prague, Czech Republic

Zdeněk Sokol

Czech Technical University, Faculty of Civil Engineering, Prague, Czech Republic

Jan Stark

Delft University of Technology, Faculty of Civil Engineering and Geosciences,  
the Netherlands

**In this paper, the concrete underneath the base plate together with the base plate is referred to as “component concrete in compression and base plate in bending” or in short “concrete in compression”. Models are presented for the determination of the resistance and stiffness of this component. The models have been validated with tests. The paper also presents finite element calculations that provide additional validation. The predicted resistances according to ENV 1993-1-1 are conservative with a margin of 1.4 to 2.5 to the test results. The stiffness of the concrete in compression depends on the quality of the execution. In case of good workmanship, there is reasonable agreement between the measured and the predicted stiffness.**

*Key words: Base plate, concrete, analytical model, tests, finite element method*

## 1 Introduction

A column base with a base plate is a common solution. In such a connection, the following components contribute to its resistance and stiffness: "concrete in compression", "base plate in bending", "column flange in compression", "column web in compression", and "anchor

bolts in tension". For the shear transfer specific components, like "anchor bolts in shear", are relevant. This paper focuses on the resistance and stiffness behaviour of the components "concrete in compression" and "base plate in bending", because of their interaction in resistance and stiffness behaviour, in the course of this paper, the combined component "concrete in compression" will refer to both "base plate in bending" and "concrete in compression". The grout layer between the base plate and the concrete has influence on the resistance and the stiffness of the component. This layer is also included in this component. The following paragraphs will discuss this in detail. Concrete in compression is stiff in comparison to anchor bolts in tension. In other words, the elongation of the anchor bolts mainly determines the stiffness behaviour of column base connections subjected primarily to bending moments. Only in case of predominant axial compressive forces, the deformation of the concrete in compression plays a role. However these deformations are then rather smaller compare to the steel part deformation and the required accuracy of stiffness predictions of concrete in compression is small from the point of view of the global analyses accuracy. In the literature about resistance of concrete in compression the following two assumptions are used:

- The base plates are assumed to be rigid.
- The connecting base plates are assumed to be flexible.

The difference between rigid and flexible plates can be explained using a base plate connection loaded by an axial force only. In case of rigid plates it is assumed that the stresses under the plate are uniformly distributed. In case of flexible plates, the stresses are concentrated around the footprint of the column section under the plate. This paper focuses on the treatment of the base plate as flexible.

Various researchers [1] to [4] experimentally investigated the resistance of concrete in compression. Factors influencing this resistance are the concrete strength, the plate area, the plate thickness, the grout, the location of the plate on the concrete foundation, the size of the concrete foundation and reinforcement. Concerning modelling, Stockwell [5] introduced the concept of replacing a flexible plate with a non-uniform stress distribution by an equivalent rigid plate with a uniform stress distribution. Bijlaard [6] and Murray [7] verified this simple practical method with experiments and suggested improvements. ENV1993-1-1 [8] adopted this method in a form suitable for standardization. This method is discussed in more detail in the next section. This paper describes design models for the resistance and stiffness of concrete in compression as proposed by an ad-hoc working group of ECCS TCIO and COST C1. Section 2 the model for determination of the load

capacity is discussed. In Section 3 a proposal is presented for an extension of the resistance model for the determination of the stiffness of this component. In Section 4 the validation of the models with tests and finite element calculations is given.

## 2 Component Resistance

The ECCS TC10 / COST C1 ad-hoc working group uses the design model for the resistance of concrete in compression given in Annex L of ENV1993-1-1 [8]. The resistance is determined by an equivalent rigid plate concept. Fig. 1 shows how an equivalent rigid plate can replace a flexible plate in case the base plate connection is loaded by axial force only. The symbol  $A$  is the area of top surface of the concrete block,  $A_p$  is the area of the plate,  $A_{eq}$  is the area of the equivalent rigid plate and  $c$  is the equivalent width of footprint. The resistance is now determined by two parameters: the bearing strength of the concrete and the dimensions of the equivalent rigid plate.

### *Bearing strength of the concrete*

The bearing strength of the concrete underneath the plate is dependent on the size of the concrete block. The edge effect is taken into account by the following definition of the concentration factor

$$k_j = \sqrt{\frac{a_l b_l}{ab}} \quad (1)$$

where the geometrical edge conditions, see Fig. 2, are introduced by

$$a_l = \min \left\{ \begin{array}{l} a + 2a_r \\ 5a \\ a + h \\ 5b_l \end{array} \right\}, \quad a_l \geq a \quad (2)$$

$$b_l = \min \left\{ \begin{array}{l} b + 2b_r \\ 5b \\ b + h \\ 5a_l \end{array} \right\}, \quad b_l \geq b \quad (3)$$

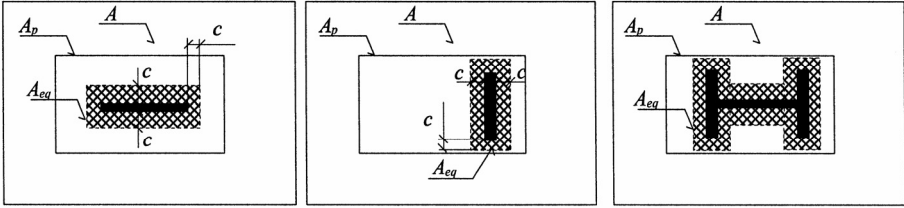

Figure 1: Flexible base plate modelled as a rigid plate of equivalent area

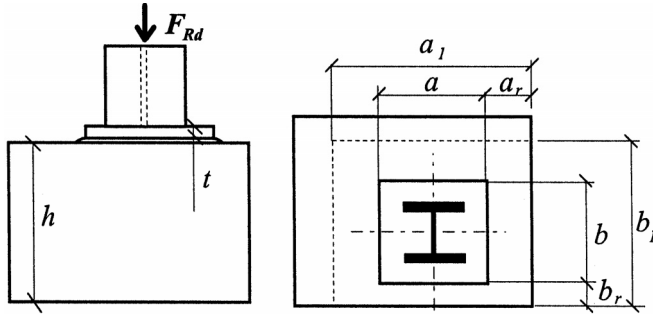

Figure 2: Evaluation of the concrete block bearing resistance

If there is no edge effect, it means that the geometrical position of the column base is sufficiently far away from the edges of the concrete and the value for  $k_j$  according to [8] is 5. This concentration factor is used for evaluation of the design value for the bearing strength as follows

$$f_j = \frac{\beta_j k_j f_{ck}}{\gamma_c} \quad (4)$$

where  $\gamma_c$  is a partial safety factor for concrete. A reduction factor  $\beta_j$  is used for taking into account that the resistance under the plate might be smaller due to the quality of the grout layer. The value  $\beta_j = 2/3$  may be used if the grout characteristic strength is more than 0,2 times the characteristic strength of the concrete foundation  $f_{c,g} \geq 0,2 f_c$  and the thickness of the grout is smaller than 0,2 times the minimum base plate width  $t_g \leq 0,2 \min(a; b)$ . These conditions are usually fulfilled. If not, the grout should be checked separately, see [6].

### Dimensions of the equivalent rigid plate

The flexible base plate, with area  $A_p$ , can be replaced by an equivalent rigid plate with area  $A_{eq}$  see Fig. 1. This rigid plate area  $A_{eq}$  is built up from one T-stub under the column web and two T-stubs under the column flanges.

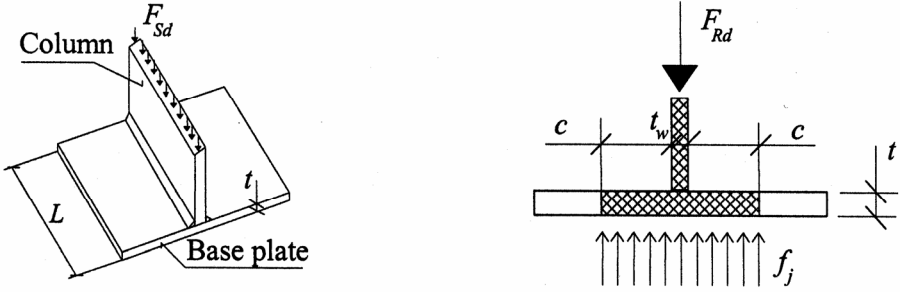

Figure 3: T-stub under compression

The equivalent width  $c$  of the T-stub, see Fig. 3, can be determined assuming that: No plastic deformations will occur in the flange of the T-stub. Therefore, the resistance per unit length of the T-stub flange is taken as the elastic resistance:

$$M' = \frac{1}{6} t^2 f_y \quad (5)$$

It is assumed that the T-stub is loaded by a uniform stress distribution. The bending moment per unit length in the base plate acting as a cantilever with span  $c$  is:

$$M' = \frac{1}{2} f_j c^2 \quad (6)$$

where  $f_j$  is concrete bearing strength. The equivalent width  $c$  can be resolved by combining equations (5) and (6)

$$c = t \sqrt{\frac{f_y}{3f_j \gamma_{M0}}} \quad (7)$$

The width of the T-stub is now

$$a_{eq,R} = t_w + 2c = t_w + 2t \sqrt{\frac{f_y}{3f_j \gamma_{M0}}} \quad (8)$$

The resistance  $F_{Rd}$  of the T-stub, see Fig. 3, should be higher than the loading  $F_{Sd}$

$$F_{Sd} \leq F_{Rd} = A_{eq} f_j = a_{eq,R} L f_j \quad (9)$$

The base plate is stiffer in bending near the intersections of web and flanges. This stiffening effect is not taken into consideration in the equivalent area  $A_{eq}$ , Studies [9] show that this stiffening effect may yield to a 3% higher resistance for open sections and a 10% higher resistance for tubular sections in comparison to the method of determination of  $A_{eq}$ . The calculation of the concentration factor  $k_j$  based on Eq. (1) leads to conservative results. This can be improved by modification of the procedure of Eqs. (1) - (3). In that case, the equivalent area instead of the full area of the plate should be considered. However, this iterative procedure is not recommended for practical purposes. In case of high quality grout a less conservative procedure with a distribution of stresses under  $45^\circ$  may be adopted see, Fig. 4.

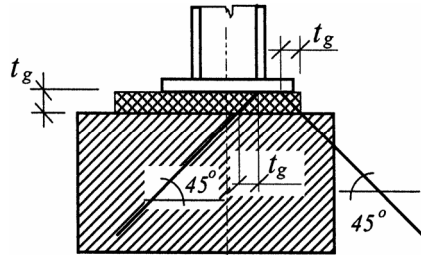

Figure 4: Stress distribution in the grout

The bearing stress under the plate increases with a larger eccentricity of the axial force [10, 11]. In this case, the base plate is in larger contact with the concrete block due to its bending and the stress in the edge under the plate increases. However, the effect of this phenomena is limited.

The influence of packing under the steel plate may be neglected for practical design [12].

The influence of the washer under plate used for construction can be also neglected in case

of grout quality  $f_{c,g} \geq 0,2 f_c$ . The anchor bolts and base plate resistance should be taken into account explicitly in case of grout quality  $f_{c,g} \leq 0,2 f_c$ .

### 3 Component Stiffness

This section presents the stiffness model for concrete in compression as proposed by the ECCS TC10 / COST C1 ad-hoc working group. The model for the elastic stiffness behaviour of the T-stub component "concrete in compression and plate in bending" is based on a similar interaction between the concrete and the base plate as assumed for the resistance.

The elastic stiffness is influenced by the following factors: the flexibility of the plate, the Young's modulus of the concrete and the size of the concrete block.

As a starting point in the modelling, the stiffness behaviour of a rigid rectangular plate supported by an elastic half space is considered. In a second step, an indication is given how to replace a flexible plate by an equivalent rigid plate. In the last step, assumptions are made about the effect of the size of the block to the deformations under the plate for practical base plates.

The deformation of a rectangular rigid plate in a half space may be simplified, see Lambe and Whitman [13], to:

$$\delta_r = \frac{F \alpha a_{rig}}{E_c A_r}, \quad (10)$$

where

- $\delta_r$  deformation under a rigid plate;
- $F$  applied compressed force;
- $a_{rig}$  width of the rigid plate;
- $E_c$  Young's modulus of concrete;
- $A_r$  area of the plate,  $A_r = a_{rig} L$  and
- $L$  length of the plate,
- $\alpha$  factor dependent on the mechanical properties of half space,  $L$  and  $a_{rig}$ , see [13].

Table 1 gives values for  $\alpha$  dependent on the Poisson's ratio ( $\nu \approx 0,15$  for concrete) of the compressed material. This table gives also an approximation  $\alpha \approx 0,58 \sqrt{L / a_{rig}}$ . With the approximation for  $\alpha$ , the formula for the displacement under the plate can be rewritten as

$$\delta_r = \frac{0,85F}{E_c \sqrt{L a_{rig}}} \quad (11)$$

Table 1: Factor  $\alpha$  and its approximation for concrete

$L/a_r$	$\alpha$ according to [13]	Approximation as $\alpha \approx 0,58\sqrt{L/a_{rig}}$
1	0,90	0,85
1,5	1,10	1,04
2	1,25	1,20
3	1,47	1,47
5	1,76	1,90
10	2,17	2,69

A flexible plate can be expressed in terms of an equivalent rigid plate based on the same deformations. For this purpose, half of a T-stub flange in compression is modelled as shown in Fig. 5.

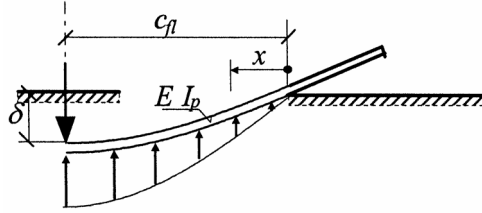

Figure 5: Flange of a flexible T-stub

It is assumed that the flange of unit width is elastically supported by independent springs. The deformation of the plate is taken to be a sine function, which is expressed as:

$$\delta(x) = \delta \sin\left(\frac{1}{2} \pi x / c_f\right) \quad (12)$$

The uniform stress in the plate can then be replaced by the fourth derivative of the deformation multiplied by  $EI_p$

$$\sigma(x) = EI_p \left(\frac{1}{2} \pi x / c_f\right)^4 \delta \sin\left(\frac{1}{2} \pi x / c_f\right) = E \frac{t^3}{12} \left(\frac{1}{2} \pi x / c_f\right)^4 \delta \sin\left(\frac{1}{2} \pi x / c_f\right) \quad (13)$$



where  $E$  is the Young's modulus of steel and  $I_p$  is the moment of inertia per unit length of the steel plate  $I_p = t^3 / 12$ . From the compatibility of the deformations is the stress in the concrete part

$$\delta(x) = \sigma(x) h_{eq} / E_c \quad (14)$$

where  $h_{eq}$  is the equivalent concrete height of the portion under the steel plate. The ration between  $h_{eq}$  and  $c_{fl}$  may be expresses by factor  $\xi$ , hence:

$$\delta(x) = \sigma(x) \xi c_{fl} / E_c \quad (15)$$

Substitution gives:

$$\delta \sin(\frac{1}{2} \pi x / c_{fl}) = \left[ E t^3 / 12 (\frac{1}{2} \pi x / c_{fl})^4 \right] \left[ \delta \sin(\frac{1}{2} \pi x / c_{fl}) (\xi c_{fl} / E_c) \right] \quad (16)$$

This may be expressed as:

$$c_{fl} = t \sqrt[3]{\frac{(\pi/2)^4}{12} \xi \frac{E}{E_c}} \quad (17)$$

The flexible length  $c_{fl}$  may be replaced by an equivalent rigid length  $c_r$  such that uniform deformations under an equivalent rigid plate give the same force as the non-uniform deformation under the flexible plate

$$c_r = c_{fl} 2 / \pi \quad (18)$$

The factor  $\xi$  represents the ratio between  $h_{eq}$  and  $c_{fl}$ . The value of  $\alpha a_{rig}$  represents the equivalent height  $h_{eq}$ , see (10). From Table 1 follows that the factor  $\alpha$  for practical T-stubs can be approximated to 1,4. The width  $a_r$  is equal to  $t_w + 2c_r$ , where  $t_w$  is equal to the web thickness of the T-stub. As a practical assumption it is now assumed that  $t_w$  equals to  $0,5 c_r$  which leads to

$$h_{eq} = 1,4(0,5 + 2)c_r = 1,4 \cdot 2,5 \cdot c_{fl} \cdot 2 / \pi = 2,2 c_{fl} \quad (19)$$

With these rough approximations:  $\xi = 2,2$ . For practical joints  $E_c \approx 30\,000$  N/mm<sup>2</sup> and  $E \approx 210\,000$  N/mm<sup>2</sup>, which leads to

$$c_{fl} = t \sqrt[3]{\frac{(\pi/2)^4}{12} \xi \frac{E}{E_c}} \approx t \sqrt[3]{\frac{(\pi/2)^4}{12} 2,2 \frac{210000}{30000}} \approx 1,98 t \quad (20)$$

or

$$c_r = c_{fl} 2 / \pi = 1,98 \cdot 2 / \pi t = 1,25 t \quad (21)$$

The equivalent width is then

$$a_{eq,el} = t_w + 2,5t = \frac{c_r}{2} + 2,5t = \frac{1,25t}{2} + 2,5t = 0,625t + 2,5t = 3,125t \quad (22)$$

The influence of the finite block size compared to the infinite half space can be neglected in practical cases.

The quality of the concrete surface and the grout layer influences the stiffness of this component, as demonstrated in tests [6] and [14]. Comparison with tests lead to the conclusion that stiffness reductions are observed from 1,0 till 1,55. Sokol and Wald [14] proposed a reduction of the design value of the modulus of elasticity of the upper layer of concrete of thickness of 30 mm based on tests without a grout layer, with poor grout quality and with high grout quality respectively. The model proposed in this paper, takes the quality of the surface into account with a stiffness reduction factor equal to 1,5.

In conclusion, the formula to calculate the stiffness coefficient  $k_c$  of concrete in compression is given in Eq. (23)

$$k_c = \frac{F}{\delta E} = \frac{E_c \sqrt{a_{eq,el} L}}{1,5 \cdot 0,85 E} = \frac{E_c \sqrt{a_{eq,el} L}}{1,275 E} \equiv \frac{E_c \sqrt{t L}}{0,72 E} \quad (23)$$

where

$a_{eq,el}$  equivalent width of the T-stub,  $a_{eq,el} = t_w + 2,5t$  ;

$L$  length of the T-stub;

$t$  flange thickness of the T-stub, the base plate thickness;

$t_w$  web thickness of the T-stub, the column web or flange thickness.

The variation if the factor  $a$  from 1,0 till 2,5, see Table 1, gives compare to the approximated value 1,4 in an error of Eq. (23) till 20 %. The equivalent width of a T-stub in the stiffness model according to Eq. (22) is different from the width in the resistance model according to Eq. (8). Fig. 6 shows the results of a parameter study where both the equivalent widths are

applied in Eq. (23). Fig. 6 is a concrete strength-deformation diagram for a flexible plate with  $t = t_w = 20$  mm,  $L = 300$  mm,  $F = 1000$  kN,  $k_j = 5$ .

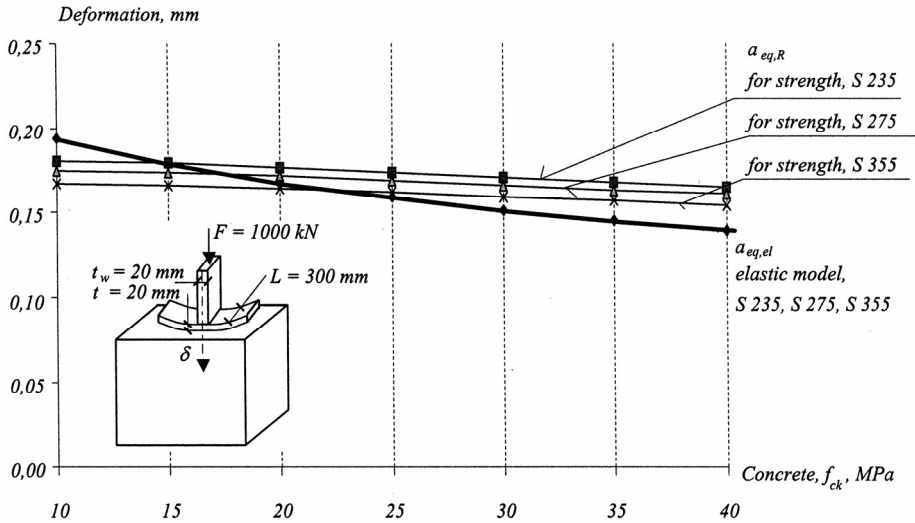

Figure 6: Concrete strength -deformation diagram for various  $a_{eq,R}$  and  $a_{eq,el}$

It can be seen from the diagram that the difference between  $a_{eq,el} = t_w + 2,5t$  and  $a_{eq,R} = t_w + 2c$  is limited. It occurs that the value of  $a_{eq,R}$  is also a sufficiently good approximation for the width of the equivalent rigid plate. This has a practical advantage for application by designers. However, the result of a stiffness calculation, with  $a_{eq,R}$  will be dependent on strength properties of steel and concrete, which is questionable from a theoretical point of view.

#### 4 Validation

The proposed resistance and stiffness models are validated with tests. For the resistance of concrete in compression, 50 tests in total were examined in this part of study [2], [3], and [4]. The test specimens consist of concrete cubes of size from 150 to 330 mm with centric load acting through a steel plate. The size of the concrete block, the size and thickness of the steel plate and the concrete strength are the main variables. Fig. 7 shows the relationship between the slenderness of the base plate, expressed as a ratio of the base plate

thickness to the edge distance and the relative bearing resistance. The design approach given in Eurocode 3 [9] is conservative compared to the test results. The bearing capacity of test specimens at concrete failure is in the range from 1,4 to 2,5 times the capacity calculated according to [9] with an average value of 1,75.

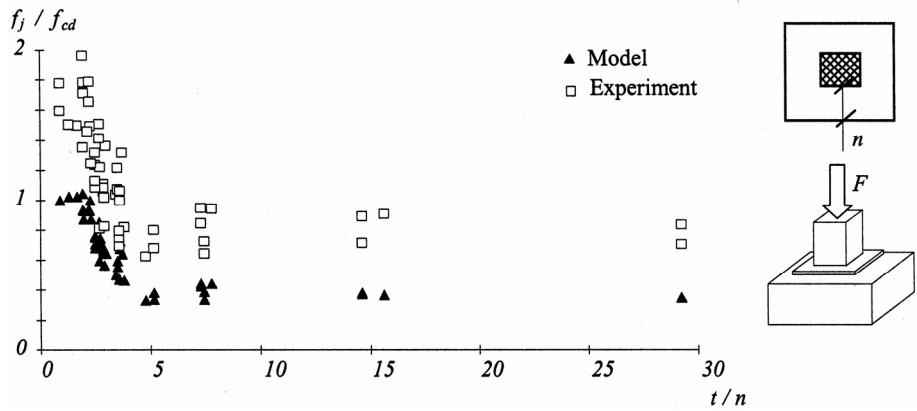

Figure 7: Relative bearing resistance-base plate slenderness relationship [2], [3] and [4]

The influence of the concrete strength is shown on Fig. 8. A set of 16 tests with similar geometry and material properties was used in this diagram [2] and [3]. The only variable was the concrete strength (19,31 and 42 MPa respectively).

The stiffness prediction is compared to tests. Fig 9 shows a typical test of Alma and Bijlaard [6]. In Fig. 10 a test of Sokol [14] is shown with a repeated load history. It concerns

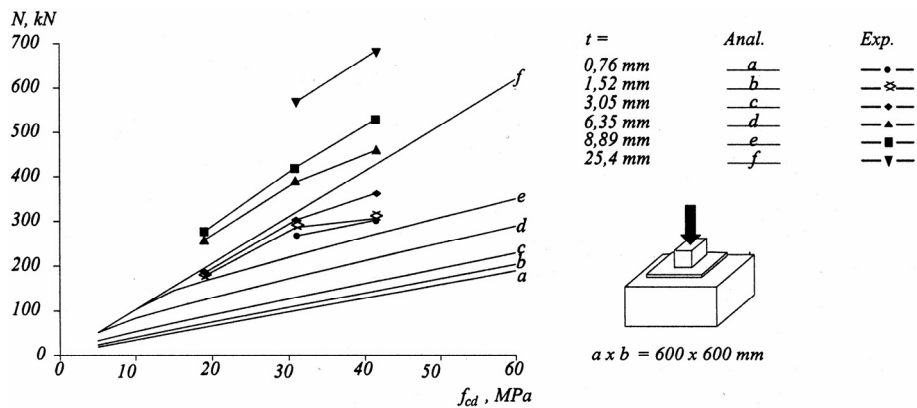

Figure 8: Concrete strength -ultimate load capacity relationship [2] and [3]

test W97-15 with repeated loading and a cleaned concrete surface without grout. The concrete block size was 550 x 550 x 550 mm with a plate thickness  $t = 12$  mm and a T-stub length  $L = 335$  mm. The deformations reported in the test are very small. The tests show that the stiffness behaviour of concrete in compression depends to the quality of the grout layer and the concrete just under the plate. In case of poor quality, for instance due to bad workmanship, the grout may be full of air bubbles, resulting a lower stiffness than predicted by the model. The workmanship is a point of further concern.

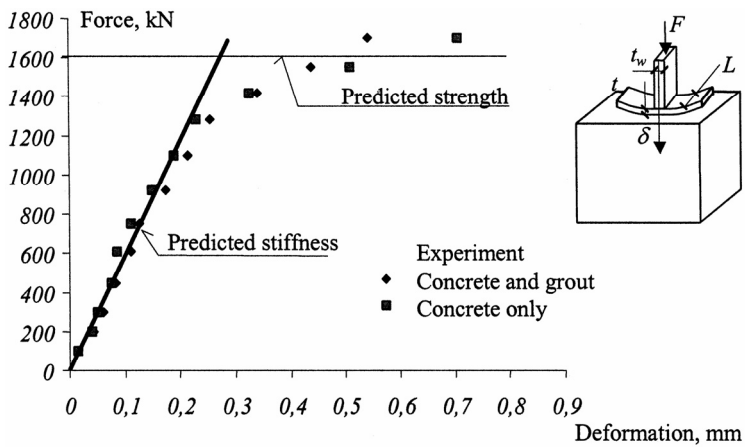

Figure 9: Comparison of the stiffness prediction to Test 1 [6]

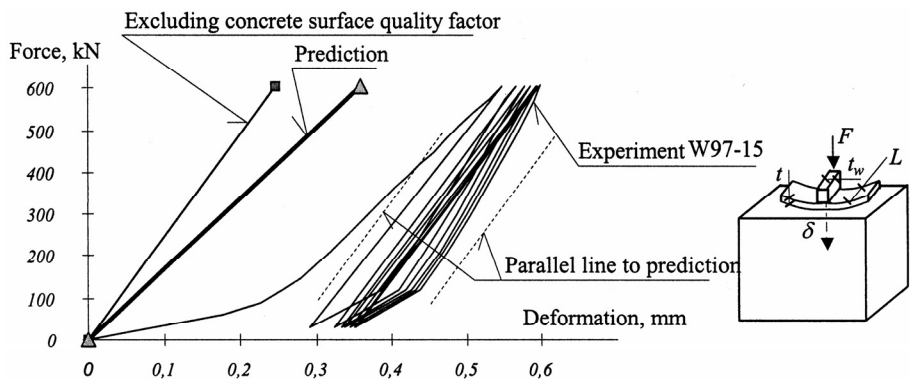

Figure 10: Comparison of the stiffness prediction to Test W97-15 [14]

The tests of flexible plates on concrete foundation are susceptible to the test set-up (rigid tests frame) and measurement accuracy (large forces and small deformations).

The predicted value based on Eq. (11) is the local deformation only, i.e. the displacement of a plate under the axial load minus the global deformation. The global deformation is the deformation of the concrete block according to Hooke's law ( $Fh/E_c A_c$ ). Just as an illustration in Fig. 11 the deformations are given as found in a Finite Element (FE) calculation. It concerns the elastic deformations of a rigid plate 100 x 100 mm on a concrete block 500 x 500 x 500 mm.

## 5 Conclusions

In this paper models are presented and discussed for resistance and stiffness of the base plate components "concrete in compression and base plate in bending". This model shows a reasonable agreement with available tests results. The values from the resistance model given in ENVI993-1-1 are conservative with a margin varying from 1,4 to 2,5, as should be expected. The quality of the grout layer is of limited influence on the resistance of the components "concrete in compression and base plate in bending".

Regarding stiffness, in case of poor grout quality, the actual stiffness may be lower than predicted with the model. In other words, the quality of the execution of the work is essential. In case of good quality of grout and concrete, the tests and predictions are in reasonable agreement. The deformations are generally small in comparison with deformations of other components and even may be neglected in many cases.

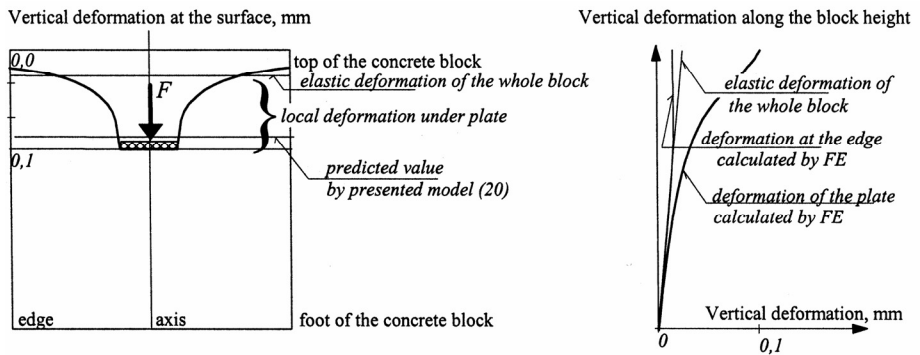

Figure 11: Calculated vertical deformations of a concrete block

### *Acknowledgement*

Within the framework of the European Project COST C1 (Semi-rigid behaviour of civil engineering structural connections) and the Technical Committee 10 of ECCS (European Convention for Constructional Steelwork) an ad-hoc working group prepared a background document on design of column bases for Eurocode 3. Members of this group are: D. Brown, SCI London; A.M. Gresnigt, TU Delft; J.P. Jaspart, University of Liège; Z. Sokol, CTU in Prague; J.W.B. Stark, TU Delft; C.M. Steenhuis, TU Eindhoven; J.C. Taylor, SCI London; F. Wald, CTU in Prague (convener of the group), K. Weynand, RTWH Aachen.

### **References**

- [1] Shelson W. Bearing Capacity of Concrete, *Journal of the American Concrete Institute*, Vol. 29, No.5, Nov., 1957, pp. 405-414.
- [2] Hawkins N.M. The bearing strength of concrete loaded through rigid plates, *Magazine of Concrete Research*, Vol. 20, No. 63, March 1968, pp. 31-40.
- [3] Hawkins N.M. The bearing strength of concrete loaded through flexible plates, *Magazine of Concrete Research*, Vol. 20, No. 63, June 1968, pp. 95 -102.
- [4] DeWolf J.T. Axially Loaded Column Base Plates, *Journal of the Structural Division ASCE*, Vol. 104, No. ST4, 1978, pp. 781-794.
- [5] Stockwell, F.W. Jr. Preliminary Base Plate Selection, *Engineering Journal AISC*, Vol. 21, No.3, 1975, pp. 92-99.
- [6] Steenhuis, C.M., Bijlaard F. S. K. Tests On Column Bases in Compression, Published in the Commemorative Publication for Prof. Dr. F. Tschemmemegg, ed. by G. Huber, Institute for Steel, Timber and Mixed Building Technology, Innsbruck 1999.
- [7] Murray T.M. Design of Lightly Loaded Steel Column Base Plates, *Engineering Journal AISC*, Vol. 20, 1983, pp. 143-152.
- [8] Eurocode 3, ENV -1993-1-1, *Design of Steel Structures -General rules and rules for buildings*, CEN, Brussels 1992, with Amendment A2, Annex J, *Joints in building frames*, CEN, Brussels 1998.
- [9] Wald F. Column-Base Connections, A Comprehensive State of the Art Review, CTU, Praha 1993.
- [10] DeWolf J. T., Ricker D. T. Column Base Plates, *Steel Design Guide, Series 1*, AISC, Chicago 1990.

- [11]Penserini P., Colson A. Ultimate Limit Strength of Column-Base Connection, Journal of Constructional Steel Research, Vol. 14, 1989, pp. 301-320.
- [12]Wald F., Obata M., Matsuura S., Goto Y. Flexible Baseplate Behaviour using FE Strip Analysis, Acta Polytechnica, CTU Vol. 33, No.1, Prague 1993, pp. 83-98.
- [13]Lambe T. W. , Whitman R.V. Soil Mechanics, MIT, John Wiley & Sons, Inc., New York 1969.
- [14]Sokol Z., Wald F. Experiments with T-stubs in Tension and Compression, Research Report PECO-AH-132, CTU, Praha 1997.

## Symbols

$a$	length of base plate
$a_l$	effective length of foundation
$a_r$	edge distance
$a_{rig}$	width of rigid plate
$b$	width of base plate
$b_l$	effective width of foundation
$c$	equivalent width of footprint
$f_{ck}$	characteristic value of concrete compressive cylinder strength
$f_j$	concrete bearing strength
$f_y$	yield stress of steel
$h$	height of foundation
$k$	stiffness coefficient
$k_j$	concentration factor
$n$	distance to plate edge
$t$	thickness of the base plate
$x$	position
$A$	area
$E$	Young's modulus, Young's modulus of steel
$E_c$	Young's modulus of concrete
$F$	force



$I'$	second moment of area per unit length
$M'$	bending moment per unit width
$L$	length of plate, length of T-stub
$\alpha$	characteristic factor
$\beta_j$	joint coefficient
$\delta$	deformation
$\gamma_{M0}$	partial safety factor for steel
$\gamma_c$	partial safety factor for concrete
$\nu$	Poisson's ratio

#### Subscripts

$c$	concrete
$d$	design
$eq$	equivalent
$el$	elastic
$fl$	flexible
$g$	grout
$r$	rigid
$p$	flexible plate
$R$	resistance
$Sd$	acting
$w$	web

